

# Owners Manual

---



---

*The Leading Manufacturer of HVLP Turbines, Spray Guns and Parts Since 1994*

# WARRANTY

THIS NEW TURBINE UNIT AND SPRAY GUN ARE COMPLETELY COVERED UNDER WARRANTY AGAINST DEFECTS IN MATERIAL AND WORKMANSHIP FOR A PERIOD OF (18) EIGHTEEN MONTHS FROM THE DATE OF PURCHASE.

AN EXTENDED LIMITED TURBINE WARRANTY IS AVAILABLE AT NO CHARGE BY RETURNING THE WARRANTY REGISTRATION CARD.

AMERICAN TURBINE WILL, AT ITS OPTION, REPAIR OR REPLACE ANY TURBINE UNIT OR GUN FOUND TO BE DEFECTIVE DURING THE ABOVE STATED WARRANTY PERIOD.

THE EQUIPMENT NEEDS TO BE RETURNED TO AMERICAN TURBINE FOR WARRANTY EVALUATION. THE COST OF SHIPPING IS THE RESPONSIBILITY OF THE OWNER.

NEGLECT, ABUSE, MISUSE OR MODIFICATION OF THE ORIGINAL EQUIPMENT WILL RENDER THIS WARRANTY NULL AND VOID. USE OF OTHER EQUIPMENT IN CONJUNCTION WITH AMERICAN TURBINE EQUIPMENT WILL RENDER THIS WARRANTY NULL AND VOID.

## CAUTION – WARNING

Our Turbines utilize a universal brush type motor. Under no circumstances are they to be used in a confined area. **A DANGEROUS EXPLOSION** may occur if the unit is used in a non- ventilated, enclosed area. Keep the turbine at least 20' from the objects being sprayed. The turbine is **NEVER** to be placed inside a spray booth. Add additional lengths of hose if the above conditions cannot be met.

Our turbines are provided with a (3) pronged grounded power cord. **DO NOT** remove the grounding prong for any reason. Any extension cord(s) used must also utilize the same configuration. Use only on electrically approved grounded outlets. In doubt? Contact a qualified electrician.

## CONTENTS

\*Asterisk represents pages with parts and part numbers

<b><u>Page 4</u></b>	<ul style="list-style-type: none"><li>• Helpful tips before spraying</li><li>• Spraying procedures</li></ul>
<b><u>Page 5</u></b>	<ul style="list-style-type: none"><li>• Corner and Edge spraying</li><li>• Shape of the spray</li></ul>
<b><u>Page 6</u></b>	<ul style="list-style-type: none"><li>• Adjusting spray pattern size</li></ul>
<b><u>*Page 7</u></b>	<ul style="list-style-type: none"><li>• Control of the material being sprayed</li><li>• Fluid set selections</li></ul>
<b><u>*Page 8</u></b>	<ul style="list-style-type: none"><li>• Needles</li><li>• Nozzles</li></ul>
<b><u>*Page 9</u></b>	<ul style="list-style-type: none"><li>• Air Caps</li></ul>
<b><u>Page 10</u></b>	<ul style="list-style-type: none"><li>• Pre-Spray Preparation</li><li>• Gun Cleaning</li></ul>
<b><u>Page 11-12</u></b>	<ul style="list-style-type: none"><li>• Gun Assembly</li></ul>
<b><u>*Page 13-14</u></b>	<ul style="list-style-type: none"><li>• Parts and Accessories</li><li>• Gun Diagram</li></ul>
<b><u>*Page 15</u></b>	<ul style="list-style-type: none"><li>• 20 &amp; 13.5 Ounce Cup Over Assembly</li></ul>
<b><u>*Page 16</u></b>	<ul style="list-style-type: none"><li>• 8 ounce Touch Up Cup Assembly</li></ul>
<b><u>*Page 17-18</u></b>	<ul style="list-style-type: none"><li>• 2 Quart Remote Cup Assembly</li><li>• 2 Quart Cup Operating Instructions</li></ul>
<b><u>*Page 19-20</u></b>	<ul style="list-style-type: none"><li>• 2 ½ Gallon Paint Tank</li><li>• 2 ½ Gallon Paint Tank Operating Instructions</li></ul>
<b><u>*Page 21</u></b>	<ul style="list-style-type: none"><li>• Turbine Unit Repair Parts</li></ul>
<b><u>Page 22-24</u></b>	<ul style="list-style-type: none"><li>• Trouble Shooting</li></ul>
<b><u>Page 25</u></b>	<ul style="list-style-type: none"><li>• CONTACT INFORMATION</li></ul>

### Helpful Tips Before Spraying

1. Make certain the proper fluid set and air cap are used for the material being sprayed.
2. Adjust the air cap to ensure the fluid set is flush with the air cap center hole.
3. After turning the turbine on, allow it to warm-up for a few minutes prior to spraying. When the turbine is not in use, remember to turn it off; there is no automatic shut off.  
  
\* If your system has a compressor, it also has to be shut off to avoid overheating.
4. Because the turbine air is warm, the material being sprayed will dry faster; therefore, the use of a slower drying thinner (reducer) may be required.

### Spraying Procedures

1. **ALWAYS** keep the turbine out of the spray area.
2. When possible spray a complete wet coat on the object being sprayed.
3. Keep the spray gun lateral when spraying, usually six to eight inches from the object being sprayed.

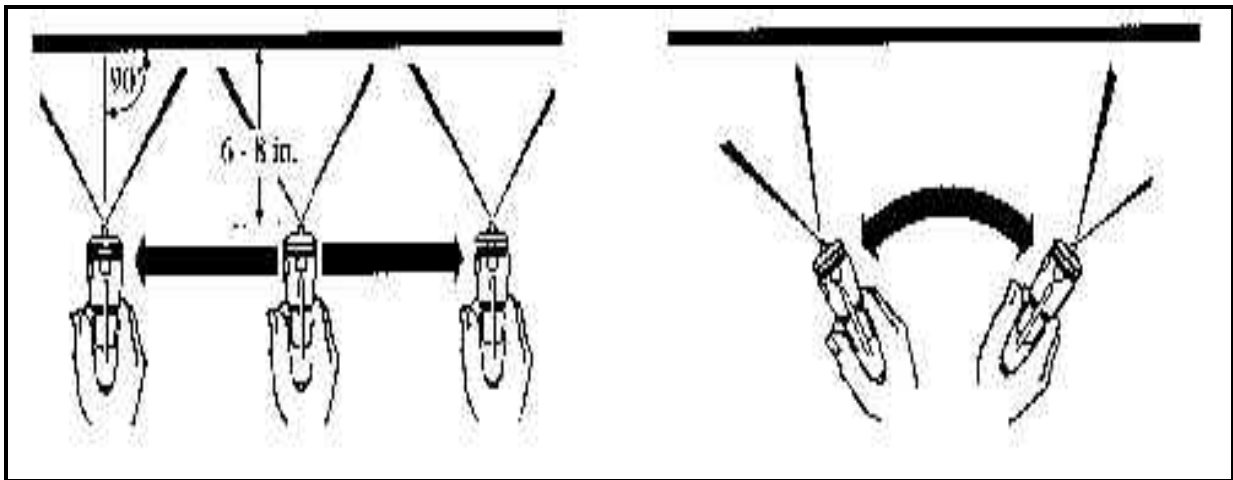

**Correct Spray Technique**

**Incorrect Spray Technique**

4. Do not trigger the spray gun until the lateral motion has begun. Also, before and after each pass, make sure to trigger the gun.
5. It is important to overlap the previous pass by about 50% to ensure an even finish.

## Corners & Edges

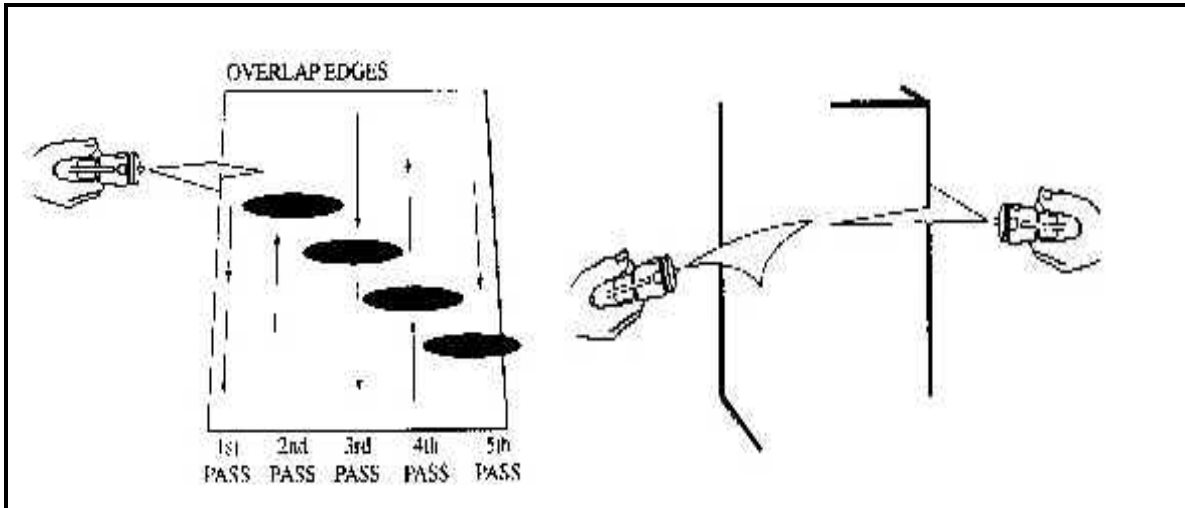

## Shape Of The Spray

To select the desired spray pattern, rotate the air cap. When the air cap is diagonal, the spray pattern will be round. When the air cap is in the horizontal position, the spray pattern will be vertical. And in the vertical position, the pattern will be horizontal.

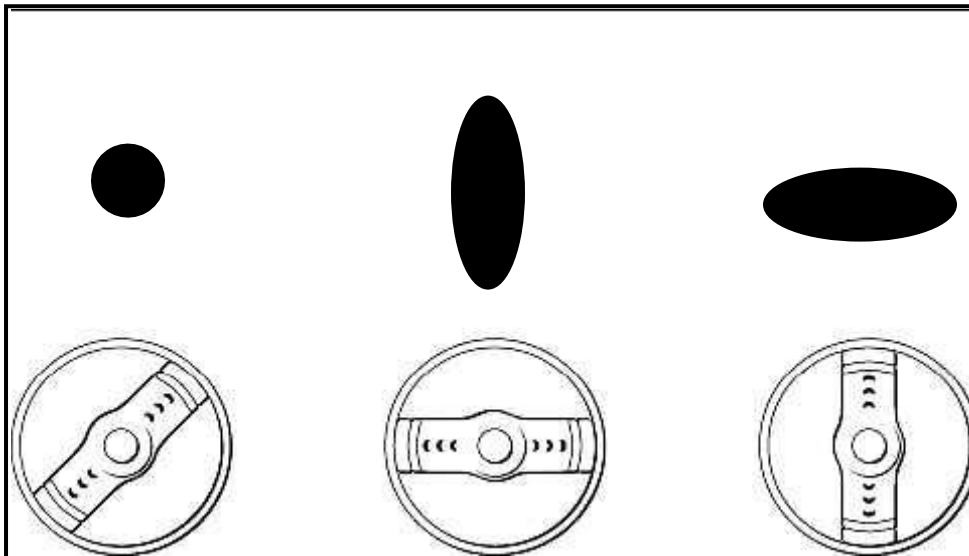

### Adjust The Size Of The Spray Pattern

By turning the pattern control ring on the front of the gun, the pattern can be adjusted from the normal pattern width (air cap and tip of the nozzle are flush). To widen the pattern, turn the pattern control ring in (clockwise) which moves the air cap closer to the nozzle. It should be noted that the closer the air cap is to the nozzle, the amount of air flow used for atomization is reduced which may cause a poor finish. To narrow the pattern, turn the pattern control ring out (counterclockwise). The further the air cap is from the nozzle the chance of excessive over spray increases.

**NOTE: If the air cap retaining ring is turned too far out, the fluid will stop or flutter.**

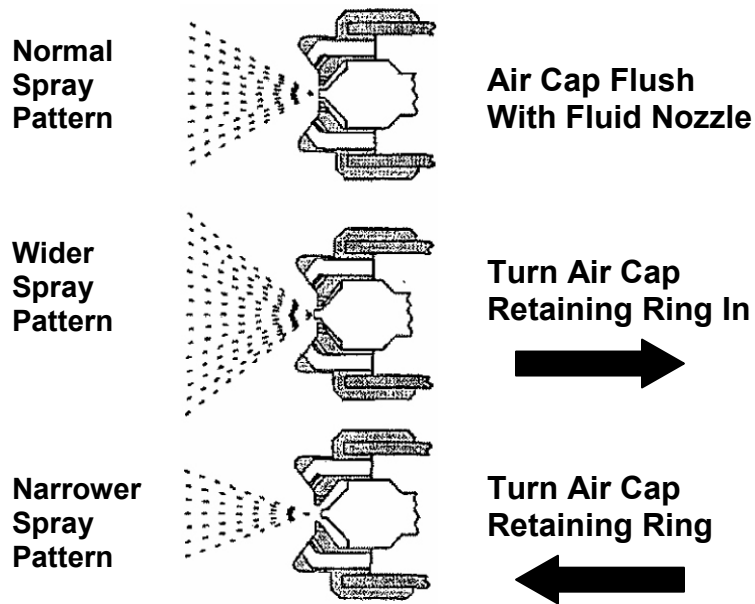

## Control Of The Material Being Sprayed

The material control knob controls the amount of material being applied. The further the knob is turned out, the greater the opening in the nozzle and more material being applied. Adjusting the knob in, reduces the amount of material being applied and limits the distance of trigger movement, which may cause the operator to over squeeze the trigger and damage the actuator.

The air control valve is used to adjust the amount of air to atomize the material being sprayed and also reduces the over spray (mist).

**Caution:** Once the spray gun is filled it is important to keep the gun upright. When in use the gun can be tilted as necessary. The internal pressure in the clear air pressure hose may become blocked if gun is placed on its side or upside down. This can prevent pressurization of the cup assembly or may cause material to flow back up into the gun body.

### Fluid Set Selections

**\*A fluid set contains both a:**

Needle



Nozzle



(mm)	Part Number	Common Usages
0.5	22201	Dyes & Inks
0.7	22202	Water born urethanes, lacquers and non-wiping stains
1.0	22203	Water born urethanes, lacquers fine finish work
1.2	22204	Lacquers, varnish, primers, enamels, stains, epoxy & urethanes. Fine finish work
1.4	22205	Lacquers, varnish, primers, enamels, stains, epoxy, urethanes
1.6	22206	Industrial finishes - higher output
1.8	22207	Industrial finishes - higher output
2.0	22208	Nitrate and butyrate dope, latex, oil wall paint, wax based strippers
2.4	22209	Latex, oil wall paint, wax based strippers
2.8	22210	Latex and oil paint, wax based strippers and other heavy bodied material

**Note:** The fluid set (needle and nozzle) must be the same size. The air cap may be larger or smaller in size than the fluid set for atomization of the material being sprayed.

The following needles and nozzles are sold separately. Use the specific part number which corresponds with the correct size needle or nozzle.

**Needles**



**Nozzles**



Needle Size mm	Part Number	Nozzle Size mm	Part Number
0.5	22101	0.5	22115
0.7	22102	0.7	22116
1.0	22103	1.0	22117
1.2	22104	1.2	22118
1.4	22105	1.4	22119
1.6	22106	1.6	22120
1.8	22107	1.8	22121
2.0	22108	2.0	22122
2.4	22109	2.4	22123
2.8	22110	2.8	22124



The following air caps are sold separately. (Unlike the needle and nozzles, **air caps can be of a different size**)

1. The smaller numbered air cap will break the material being sprayed into smaller particles for a finer finish.
2. Larger numbered air cap may reduce the amount of over spray mist.
3. For fine finish work, it is recommended that a multi-hole air cap be used.

**Air Caps**

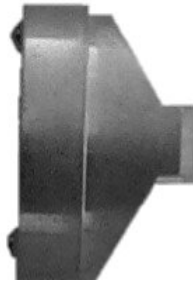

Standard Air Cap		Multi Hole Air Cap	
Size mm	Part Number	Size mm	Part Number
0.5	22128	0.5	22140
0.7	22129	0.7	22141
1.0	22130	1.0	22142
1.2	22131		
1.4	22132		
1.6	22133		
1.8	22134		
2.0	22135		
2.4	22136		
2.8	22137		

For fine finish work, a **multi-hole** air cap is recommended.

### **Preparation Prior to Spraying**

1. Make sure the surface to be sprayed has been cleaned and dry.
2. Filter all material to be sprayed through the appropriate strainer to avoid impurities.
3. Practice on a test panel and make adjustments to the gun, speed of application, or the material being sprayed.
4. Always follow the manufacturer's instructions for the correct reducer of the material being sprayed.

**QUICK TEST:** Submerge a paint stick into the material, remove the stick and if the droplets are about 1 second apart, the correct reduction has been made.

### **CLEANING GUN AFTER USE**

1. Turn off the turbine and disconnect the gun.
2. Remove the cup and remove all excess material.
3. Put a small amount of suitable cleaner in the cup.
4. Replace the cup on the gun, turn on turbine, and spray cleaner through the gun.
5. Remove the pattern control ring, detent plate, detent spring, and clean.
6. Remove the material control body, fluid needle, and clean.
7. Remove the nozzle, and clean.
8. Remove the air pressure tube between gun body and the cup lid, and clean.
9. Remove the cup assembly by loosening the nut from the fluid fitting, clean the lid and the pick up tube with the brush.
10. Remove the lower pressure tube (blue) from the elbow and clean both with the brush.
11. Use the brush and clean both the nozzle holder and the fluid fitting.
12. Blow off all parts and let dry.
13. Apply a thin coat of Vaseline to the needle shaft, the threads of the material control body, the adjustment screw, & the pattern control ring.

**NOTE:** When removing or replacing the cup assembly or material hose, the fluid fitting should be held in place with a wrench to avoid moving the nozzle holder.

## ASSEMBLY

1. Reassemble cup assembly and secure to the fluid fitting.
2. Connect the clear air pressure hose between the lid assembly and the gun body.
3. Insert the needle through the nozzle holder and adjust the packing if required.

### NEEDLE PACKING ADJUSTMENT

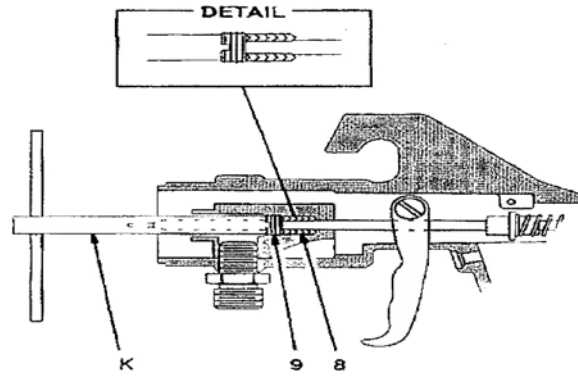

With the needle sticking through the nozzle holder, slide the packing adjustment tool (22723) over the needle into the two slots on the packing adjustment screw. Trigger the gun at the same time as tightening the packing adjustment screw until the packings grip the needle. When this happens, back off the adjustment screw 1/4 turn. The needle should now move freely.

4. Install nozzle and tighten with nozzle wrench.
5. Adjust needle for trigger play if needed. The gun is preset with about 1/8" trigger play.
  - I. Loosen the lock nut on needle.
  - II. Push the back of the needle by hand all the way into the nozzle. (So the needle and nozzle are completely closed) and check for trigger play.
  - III. Adjust the adjustment drum to obtain 1/8" play in the trigger and secure the lock nut.

**NOTE:** Adjustment of the packing, or of the trigger play will most likely **not** have to be performed on a regular basis, unless needle is removed or adjusted.

6. Replace the spring and material control body.

## **ASSEMBLY CONTINUED**

### **CHECK FOR NOZZLE ALIGNMENT**

Trigger the gun and feel if it is operating smoothly. Make sure the tip of the needle is flush with the nozzle. Trigger the gun while looking through the bore of the nozzle to see if the nozzle is in alignment with the needle. If not, place a 5/8" deep socket over the nozzle and **LIGHTLY tap** the nozzle with a mallet in the direction that it is out of alignment. Then check for proper alignment by placing the air cap on nozzle and spinning. If the air cap spins freely, the nozzle holder is aligned.

7. Replace the detent spring, detent plate, air cap and pattern control ring.  
Adjust so the end of the nozzle is flush with the center hole of the air cap.

### **IMPORTANT**

It is extremely important **NOT** to over tighten the pattern control ring. This will cause very poor atomization of the material being sprayed as it will restrict the flow of air from around the air cap causing inconsistent material flow and material leakage into the gun body.

The material control knob is a mechanical stop for the movement of the needle and trigger. By adjusting the material control knob to reduce material flow, the trigger will move only to the point of adjustment. Trying to over squeeze the trigger beyond the adjustment may cause damage to the actuator or related parts.

**PARTS AND ACCESSORIES**

Turbine air hose is 3/4" in diameter. The spring style hoses are designed and recommended for use from the turbine system. Hoses without the spring are used for extensions from the spring hose.

<b>Air Hose with Spring</b>		<b>Air Hose Extension</b>	
<b>Length in Feet</b>	<b>Part Number</b>	<b>Length in Feet</b>	<b>Part Number</b>
20'	41020	5' Black Flex Hose	41006
25'	41025	10'	41010
30'	41030	15'	41015
40'	41040	20'	41021
		25'	41026

\*Other hose lengths available.

Standard lined material hoses are 1/4" and 3/8" in diameter.

<b>1/4" Material Hose</b>		<b>3/8" Material Hose</b>	
<b>Length in Feet</b>	<b>Part Number</b>	<b>Length in Feet</b>	<b>Part Number</b>
5 1/2'	41055	25'	41075
20'	41060	40'	41086
25'	41065		
30'	41066		

\*Other hose lengths available.

## Gun Diagram



Ref. #	Part #	Description	Ref. #	Part #	Description	Ref.#	Part #	Description
	22000	Gun Body Only	14	22014	Locking Ring	28	22700	Bridge
1	22001	Actuator	15	22015	Spring Detent Plate	29	22706	Gasket
2	22002	Actuator Pin	16	22016	Detent Plate	30	22705	1 Qt. Cup
3	22003	Nozzle Holder Complete	17	22017	Pattern Control Ring	31	22726	Pressure Hose Lower-Blue
4	22004	Nozzle Holder Only	18	22018	Trigger Pin Guide	32	22703	Cover
5	22005	Packing (5 piece)	19	22019	Trigger Pin	33	22702	Lever
6	22006	Packing Adjustment Screw	20	22021	Trigger Screw	34	22704	Pick Up Tube
7	22007	Driving Ring	21	22707	Set Screw Gun to QD	35	22712	Gun Male QD
8	22008	Driving Ring Spring	22	22020	Trigger	36	22721	O Ring for QD
9	22009	Adjustment Drum	23	22714	Barbed Elbow	37	22701	Nut Pick Up Tube
10	22010	Locking Nut	24	22709	Plug for Pressure Gun	38		N/A
11	22011	Needle Return Spring	25	22708	Hose to Pressure Cup	39		N/A
12	22012	Body Material Control	26	22725	Hose Barb Cup Lid	40	22022	Fluid Fitting
13	22013	Adjustment Screw	27	22727	Elbow Cup Lid	41	22715	Grip

# **PART NUMBERS 30600, 30400** **CUP OVER ASSEMBLY 20 & 13.5 OZ.**

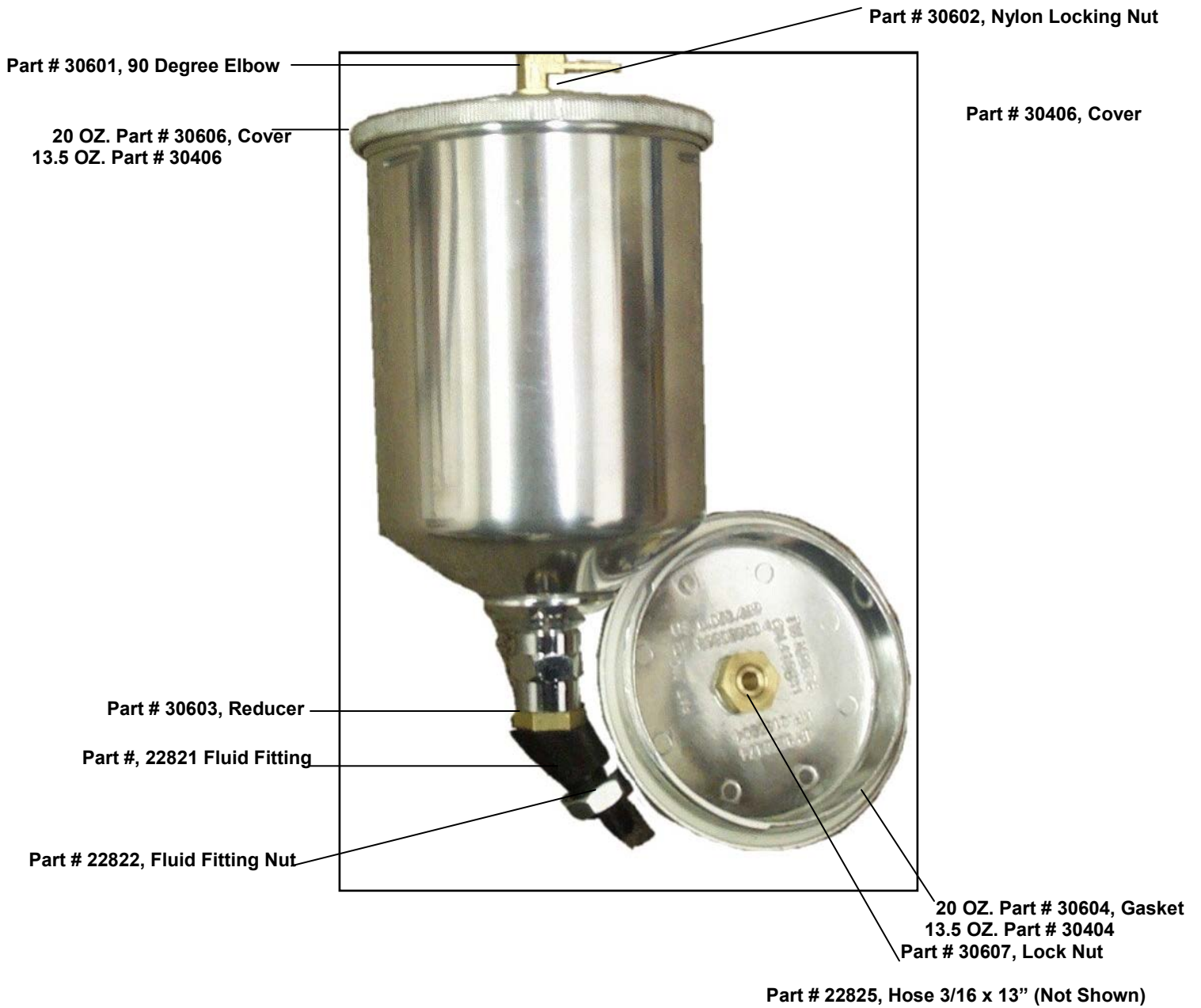

# **PART NUMBER 30032** **8 OZ. TOUCH UP CUP ASSEMBLY**

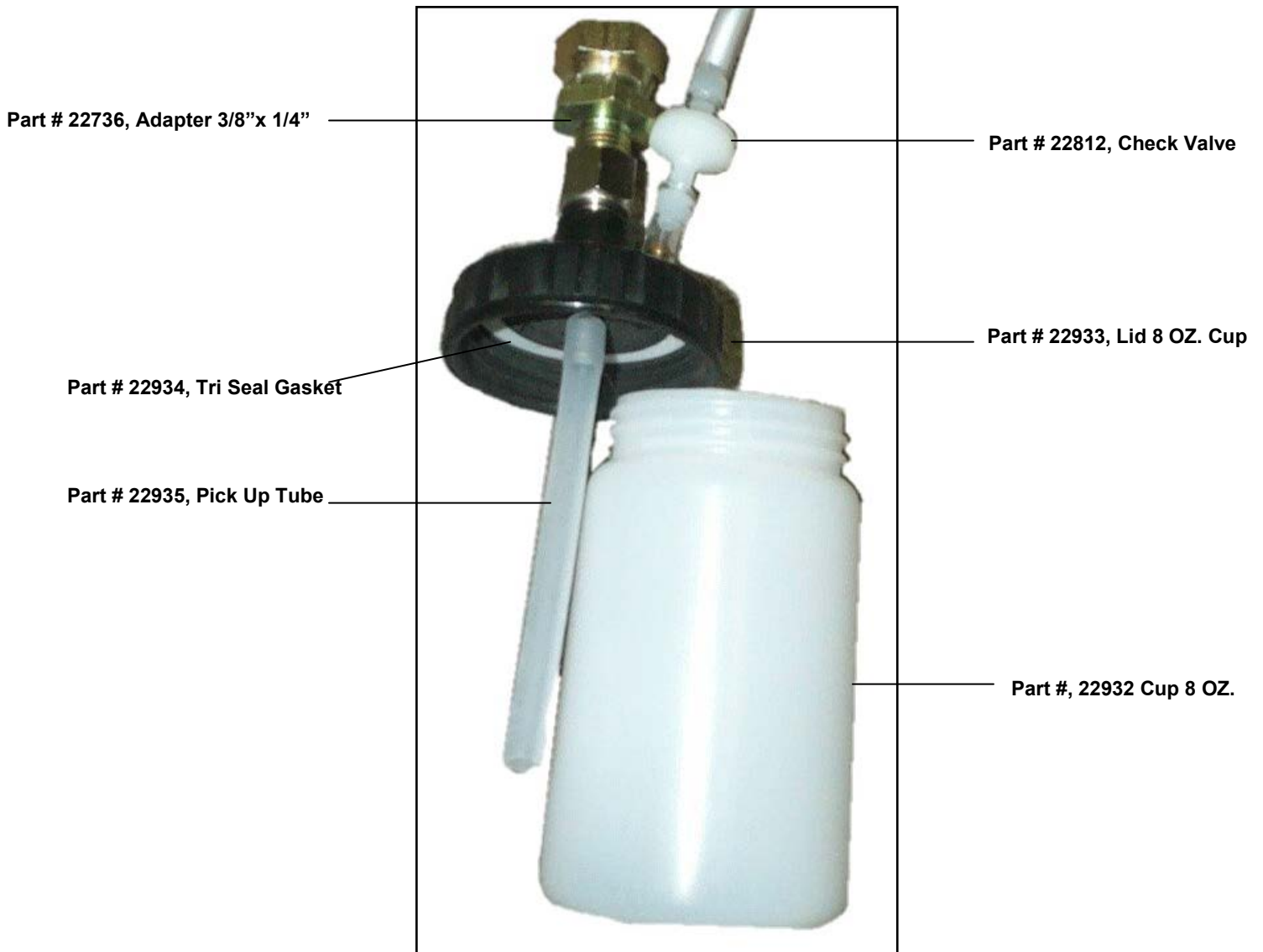

**NOTE:** Check valves are used to prevent material from backing up in to the gun. Install with the air flow toward the cup.



# PART NUMBERS 30012, 30016

## 2 QUART REMOTE CUP ASSEMBLY

### TURBINE & SHOP AIR

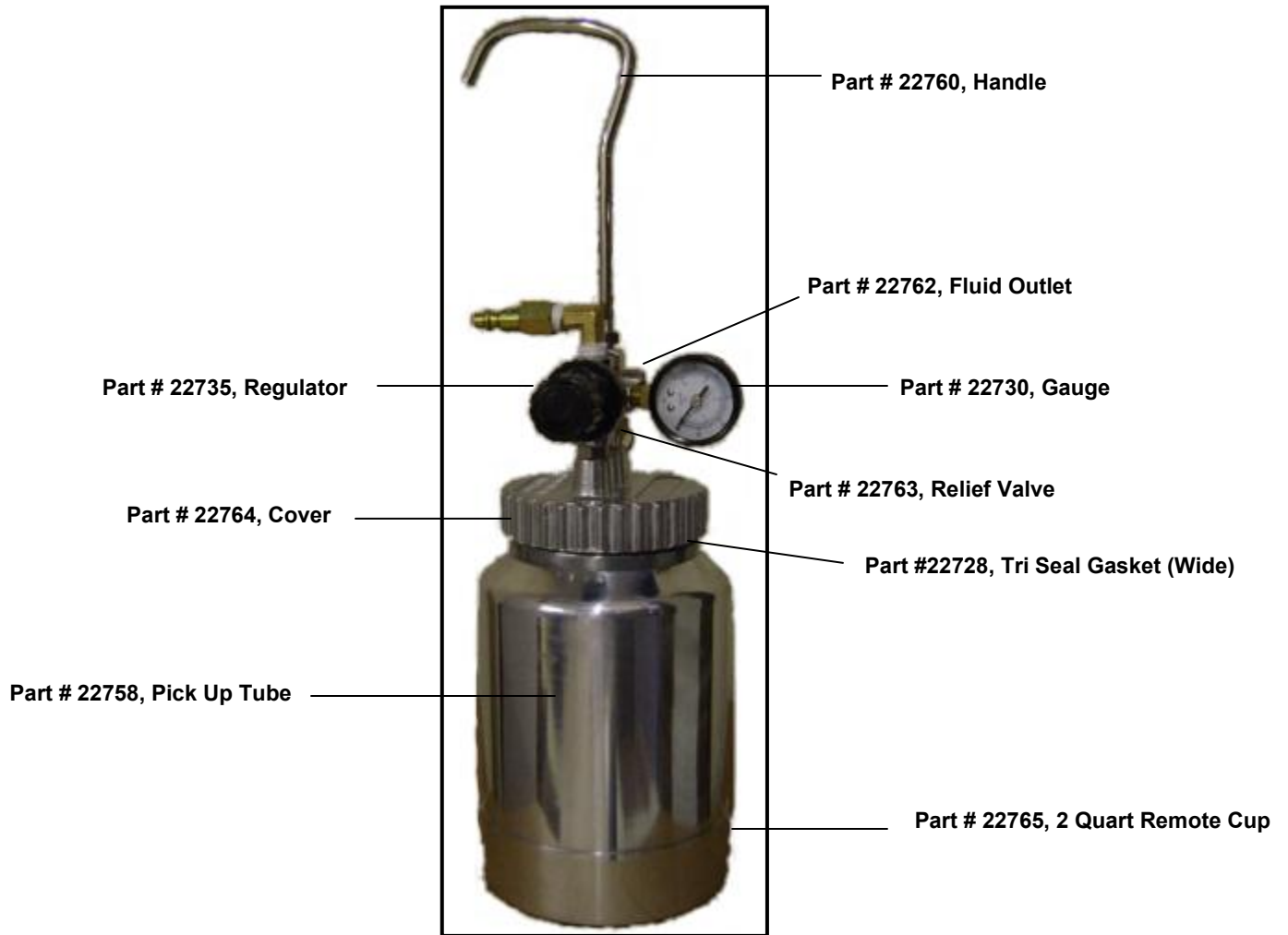

Part #	Description
30012	Turbine Air
30014	Turbine Air with Hoses
30016	Shop Air
30018	Shop Air with Hoses

**WARNING:** Always relieve pressure in the cup assembly with relief valve before loosening or removing the cover.

**NEVER EXCEED THE RATED PSI INDICATED ON THE COVER**

## 2 QUART REMOTE CUP ASSEMBLY OPERATING INSTRUCTIONS

1. Ensure the regulator is backed off all of the way.
2. With the air and material hoses connected, only switch on the compressor and slowly increase the pressure while triggering the gun until the material stream, of a medium viscosity material, makes an arch (drop) of 8-12 inches from the gun. NOTE: Lighter material may require a longer stream and heavier material may require a considerably shorter stream. Practicing this procedure along with trial and error will be beneficial.
3. Turn on the turbine air and adjust the air control valve for the optimal material atomization.
4. Fine tune tank and gun adjustments as necessary for material being sprayed.

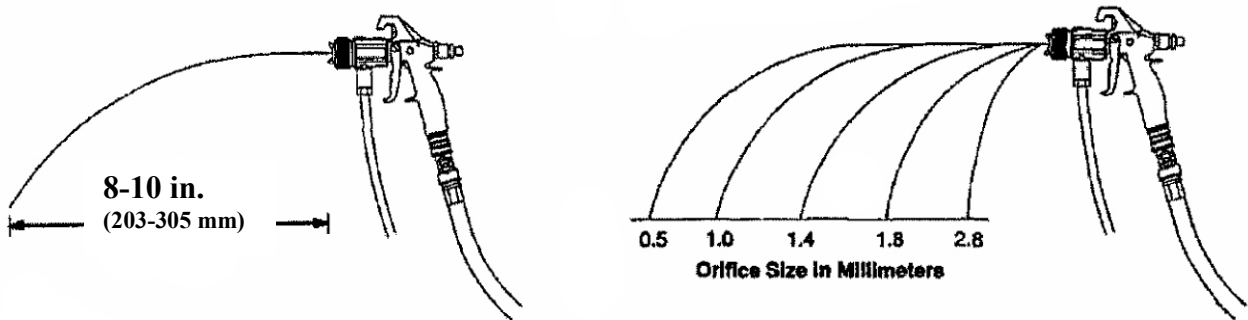

### NOTE:

1. A 2 quart remote pressure pot typically should be set at 2 to 4 psi (0.14 to 0.56 bar).
2. Heavier fluid or a long fluid hose will require more pressure
3. Turn turbine and compressor completely off when not in use as compressor will overheat if left running with the turbine turned off.
4. Always keep cup in upright position to avoid material from entering the regulator and relief valve.
5. Hand tighten cover only, this will avoid gasket damage.

# PART NUMBERS 30080, 30083

## 2 1/2 GALLON PAINT TANK

### TURBINE & SHOP AIR

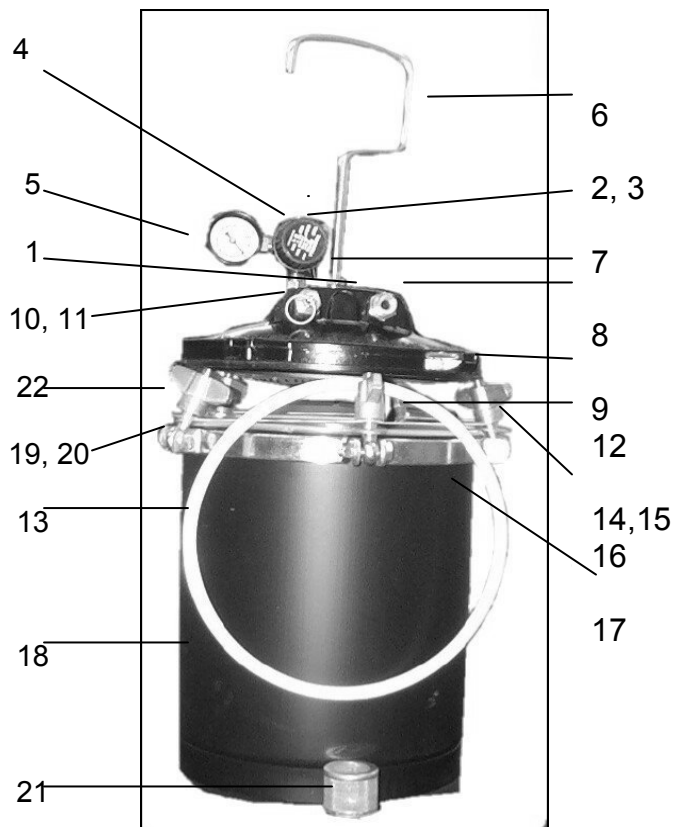

#### WARNING

Never exceed 50 PSI into the tank.

Never attempt to remove cover or work on gun until ALL pressure has been relieved from the tank.

#### CAUTION

Only hand tighten container wing nuts.

Once pressure has been applied to the container, the gun is loaded.

#### \*\*\*NOTE\*\*\*

Turn both the turbine and the compressor completely off when not in use as compressor will overheat.

Ref. #	Part #	Description	Ref. #	Part #	Description	Ref.#	Part #	Description
1	22731	Hex Nipple	9	22782	Tank Cover	17	22709	Band Segment
2	22752	Elbow 1/4" Shop Air 1/4" T	10	22785	O Ring	18	22780	2 1/2 Gallon Tank
3	22746	Male Plug QD	11	22784	Relief Valve	19	22716	Bolt (Segment)
4	22735	Regulator	12	22786	Fluid Pipe	20	22795	Nut (Segment)
5	22730	Gauge 0-30 PSI	13	22737 22742TS	Lacquer Gasket Tri-Seal Gasket	21	22716	Strainer
6	22752	Handle	14	22782	Wing Nut	22	22798	Molded Liner
7	22783	Handle Nut	15	22788	Washer	22	30085	Molded Liner 5 Pack
8	22797	Material Hose Connector	16	22789	Eye Bolt	22	30082	Molded Liner 10 Pack

Note: P/N 30080 is for turbine air use. The air supply connection to the tank is P/N 22752 ELBOW fitting and P/N 22746 male plug.

P/N 30083 is for shop air use. The air supply connection to the tank and spray gun is P/N 1/4" TEE fitting.

# **2 1/2 GALLON PAINT TANK OPERATING INSTRUCTIONS**

1. Connect material hose from tank fluid outlet fitting to the gun.
2. With the turbine and compressor off, turn the regulator control knob counter clockwise until it stops.
3. Turn compressor on and slowly increase the pressure while at the same time triggering the gun until a fluid stream of 8" to 10" is obtained before an arch (drop) in the stream occurs.
4. Turn the turbine on and adjust atomizing air with the air valve.

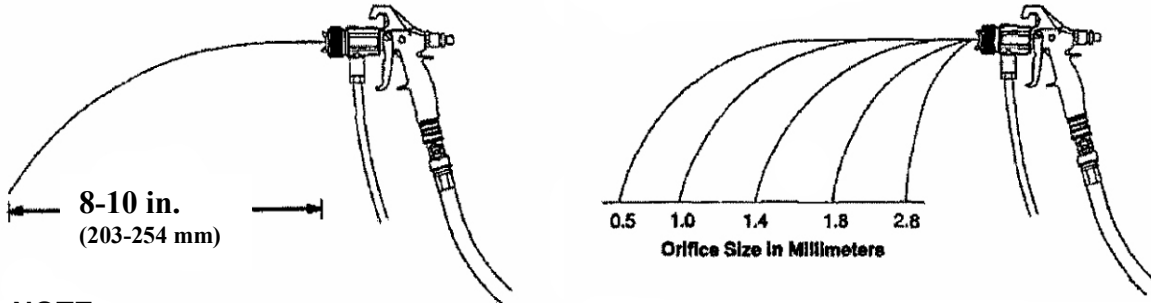

## **NOTE:**

1. A 2 ½ gallon remote pressure pot typically should be set at 4 to 8 psi (0.28 to 0.56 bar).
2. Heavier fluid or a long fluid hose will require more pressure.

## **NOTE: Compressor Equipped Systems**

A diaphragm type compressor is used in the AT 3500, AT 3550 and AT 4000 Plus systems to pressurize the remote tank assemblies. If the unit has been stored for an extended period of time or stored in a cool area, the diaphragm may become stiff and will require the manual turning of the compressor. If so,

1. Place unit in warm area.
2. **DO NOT** plug in unit.
3. Remove the pre-filter and main filter.
4. Manually rotate the cooling fan on the compressor several rotations.
5. Plug in power cord and switch the compressor on.
  - A. If compressor will not run, disconnect power cord and repeat steps 4 & 5.
6. Replace main filter and pre-filter.

Always turn the Compressor and Turbine off when not in use. The compressor will overheat if left running without the turbine on.

**WARNING: NEVER EXCEED 50 PSI IN ANY PAINT TANK OR REMOTE CUP**

# AMERICAN TURBINE TURBINE UNIT REPAIR PARTS

\*This list of parts represents the most common repair and replaceable parts for the unit listed.

## AT 950 & AT 953



Turbine	30057	30058
Switch	51065	51065
Power Cord	51029	51029
Main Filter	30099	30099
Pre-Filter	30098	30098

## AT1000 AT1000+ AT3000 AT4000

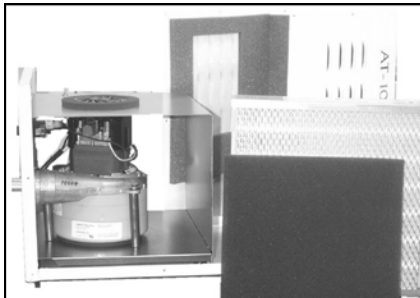

Turbine	30057	30058	30073	30074
Switch	51065	51065	51065	51065
Power Cord	51029	51029	51029	51029
Main Filter	51030	51030	51030	51030
Pre-Filter	51031-1	51031-1	51031-1	51031-1

## AT 1500 AT1500+ AT3500 AT3550

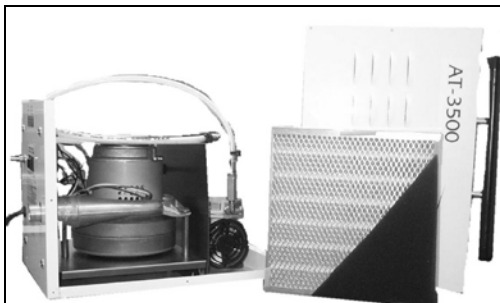

Turbine	30057	30058	30073	30073
Switch	51065	51065	51065	51065
Power Cord	51029	51029	51029	51029
Comp. Switch	51075	51075	51075	51075
Main Filter	51030	51030	51030	51030
Pre-Filter	51031	51031	51031	51031
Compressor	51073	51073	51073	51073
Dump Valve	22747	22747	22747	22747

# TROUBLE SHOOTING

Problem	Probable cause	Solution
Turbine not operating at all.	<ul style="list-style-type: none"> <li>A. No power to the turbine unit.</li> <li>B. Rocker switch tripped.</li> </ul>	<ul style="list-style-type: none"> <li>A. Check power source.</li> <li>B. Turn switch off and on to reset. If caused by excessive heat, allow unit to cool.</li> </ul>
Low air flow.	<ul style="list-style-type: none"> <li>A. Filter is blocked.</li> <li>B. Unit discharge vents are obstructed.</li> <li>C. Kink in hose.</li> <li>D. Broken or damaged hose.</li> </ul>	<ul style="list-style-type: none"> <li>A. Clean or replace pre-filter or main filter as necessary.</li> <li>B. Allow air to move freely around unit.</li> <li>C. Keep hose as straight as possible.</li> <li>D. Repair or replace hose.</li> </ul>
Turbine overheating.	<ul style="list-style-type: none"> <li>A. Ambient air is hot.</li> <li>B. Turbine filters are blocked.</li> <li>C. Turbine vents are blocked.</li> <li>D. Turbine hose too short.</li> </ul>	<ul style="list-style-type: none"> <li>A. Use in a cooler environment.</li> <li>B. Clean or replace filters.</li> <li>C. Allow air to move freely around unit.</li> <li>D. Additional lengths of turbine hose may help but may decrease gun pressure.</li> </ul>
Uneven spray pattern.	<ul style="list-style-type: none"> <li>A. Air cap holes plugged.</li> <li>B. Dry solution on fluid tip.</li> <li>C. Incorrect fluid set.</li> </ul>	<ul style="list-style-type: none"> <li>A. Clean air cap.</li> <li>B. Clean tip.</li> <li>C. Use correct fluid set for material being sprayed.</li> </ul>
Material leaking from cup and/or bubbling in cup.	<ul style="list-style-type: none"> <li>A. Gasket leaking.</li> <li>B. Lid assembly leaking.</li> </ul>	<ul style="list-style-type: none"> <li>A. Replace gasket.</li> <li>B. Check lid assembly for leaks.</li> </ul>
Material leaking in gun body.	<ul style="list-style-type: none"> <li>A. Packing loose.</li> <li>B. Crack in nozzle holder or fluid fitting.</li> <li>C. Material in remote container over pressurized.</li> </ul>	<ul style="list-style-type: none"> <li>A. Packing needs adjustment.</li> <li>B. Replace nozzle holder or fluid fitting.</li> <li>C. Reduce air pressure in remote container.</li> </ul>
Not spraying or inconsistent material flow (Spitting).	<ul style="list-style-type: none"> <li>A. Air cap too close to nozzle.</li> <li>B. Dry solution in fluid set.</li> <li>C. Material dried in blue cup pressure tube.</li> <li>D. Cracked pick up tube.</li> <li>E. Worn out cup gasket.</li> <li>F. Cracked or plugged clear hose from gun to cup.</li> <li>G. Insufficient pressure in paint tank.</li> <li>H. Fluid hose plugged.</li> <li>I. Fluid hose kinked.</li> <li>J. Tank not sealed.</li> <li>K. Low material in tank/cup.</li> </ul>	<ul style="list-style-type: none"> <li>A. Increase space between the nozzle and air cap.</li> <li>B. Clean fluid set.</li> <li>C. Clean or replace tube.</li> <li>D. Replace pick up tube.</li> <li>E. Replace cup gasket.</li> <li>F. Replace clear hose.</li> <li>G. Increase pressure to pressure tank.</li> <li>H. Disconnect fluid hose from gun and increase pressure in tank to flush hose.</li> <li>I. Remove kink and straighten hose.</li> <li>J. Check gasket for leak and tighten cover.</li> <li>K. Add material.</li> </ul>

# TROUBLE SHOOTING

Problem	Probable cause	Solution
Material leaking from the fluid tip.	A. Damage to needle or nozzle.	A. Check for a loose fluid nozzle or a bent nozzle or needle; tighten the nozzle or replace parts as needed. B. Check the needle adjustment. D. Check the needle packings adjustment.
Excessive over-spray.	A. Excessive air volume for material being sprayed. B. Spraying too far from the surface.	A. Adjust air control valve to reduce air volume to gun. C. Spray 6" to 8" from surface.
Runs or sags.	A. Material has been over diluted. B. Application speed too slow. C. Improper overlapping. D. Fluid set too large. E. Film thickness too thick for one coat. F. Gun too close to the surface. G. Insufficient atomizing air.	A. Add undiluted material, mix thoroughly and flush gun with mixture. B. Increase application speed. C. Overlap passes up to 50%. D. Replace fluid set. E. Spray multiple coats. F. Spray 6" to 8" from surface. F. Open air valve completely. Try different air valves.
Orange peel.  (Finish has texture of an orange peel. Dimpled, and often glossy.)	A. Insufficient dilution. B. Incorrect thinning solvent, solvent evaporating too fast. C. Gun too far from the surface. D. Film thickness too thin. E. Incorrect amount of atomizing air. F. Ambient temperature too high.	A. Check viscosity, add thinning solvent. C. Use slower thinning solvent or retarder. C. Spray 6" to 8" from surface. D. Apply wetter coat. E. Adjust air control valve, or try different air caps. G. Reduce temperature in spray area and/or add retarder. H. Keep the object being sprayed out of direct sunlight.

# TROUBLE SHOOTING

Problem	Probable Cause	Solution
<p>Fish eyes.</p> <p>(Small depressions in the paint film that normally form when sprayed.)</p>	<p>A. Contamination on the surface (oil, moisture, etc.) that prevents the material from adhering to the surface.</p>	<p>A. Almost impossible to Correct once the surface has been sprayed. Always make sure surface is clean and dry prior to spraying.</p>
<p>Dry spray.</p> <p>(Surface is dull, low in gloss, and rough with dry paint particles on the surface.)</p>	<p>A. Gun too far from the surface.</p> <p>B. Incorrect amount of atomizing air.</p> <p>C. Incorrect thinning solvent, evaporating too fast.</p> <p>D. Film thickness too thin.</p> <p>E. Application speed too fast.</p>	<p>A. Spray 6" to 8" from surface.</p> <p>B. Adjust air control valve.</p> <p>C. Use slower thinning solvent or retarder.</p> <p>D. Apply wetter coat.</p> <p>E. Slow down speed of spraying motion.</p>
<p>Blushing.</p> <p>(Large whitish area in the finish.)</p>	<p>A. High humidity in the spray area. Moisture has condensed in the coating as it is sprayed.</p> <p>B. Incorrect thinning solvent, evaporating too fast.</p>	<p>A. Allow the turbine to heat up a few minutes before spraying.</p> <p>B. Store the lacquer off concrete floors, at room temperature.</p> <p>C. Apply lighter coats and allow for proper drying time.</p> <p>E. Reduce humidity in the spray area and/or add retarder.</p> <p>F. Use slower thinning solvent or retarder.</p> <p>G. Do not spray in windy conditions.</p>
<p>Solvent pops or bubbles</p>	<p>Sprayed surface drying before solvent gas can be released.</p>	<p>A. Apply fluid in lighter coats to allow for proper evaporation.</p> <p>B. Use the recommended thinners.</p> <p>H. Follow the solutions above for <i>Orange peel</i> finish.</p>



# AMERICAN TURBINE

---

2517 E. 7<sup>TH</sup> AVENUE  
P.O. BOX 9115  
NORTH SAINT PAUL, MN 55109

PHONE: 651-748-8030  
FAX: 651-748-0028  
TOLL FREE: 1-877-748-4857

EMAIL: [ATI@AMERICAN-TURBINE.COM](mailto:ATI@AMERICAN-TURBINE.COM)

WEBSITE: [WWW.AMERICAN-TURBINE.COM](http://WWW.AMERICAN-TURBINE.COM)