

DISTRIBUTED BY:
Pro Wood Finishes
14622 Southlawn Lane
Rockville MD 20850
Ph: (301) 424-3033



DOCUMENTATION - DOKUMENTATION - DOCUMENTACIÓN

PISTOLET / GUN / PISTOLE / PISTOLA

XCITE™

AIRMIX®

Notice / Manual / Betriebsanleitung : 582.006.110 - 1605

Date / Datum / Fecha : 27/05/16

Annule / Supersede / Ersetzt / Anula :

Modif. / Änderung :

NOTICE ORIGINALE / TRANSLATION FROM THE ORIGINAL MANUAL
/ ÜBERSETZUNG DER ORIGINAL BETRIEBSANLEITUNG
/ TRADUCCIÓN DEL MANUAL ORIGINAL

IMPORTANT : Lire attentivement tous les documents avant le stockage, l'installation ou la mise en service du matériel concerné (à usage strictement professionnel).

Before assembly and start-up, please read and clearly understand all the documents relating to this equipment (professional use only).

WICHTIGER HINWEIS: Vor Lagerung, Installation oder Inbetriebnahme des Geräts bitte sämtliche Dokumente sorgfältig lesen (Einsatz nur von geschultem Personal).

IMPORTANTE : Lea con atención todos los documentos antes de almacenar, instalar o poner en marcha el equipo (uso exclusivamente profesional).

PHOTOS ET ILLUSTRATIONS NON CONTRACTUELLES. MATÉRIELS SUJETS A MODIFICATION(S) SANS PREAVIS.

THE PICTURES AND DRAWINGS ARE NON CONTRACTUAL. WE RESERVE THE RIGHT TO MAKE CHANGES WITHOUT PRIOR NOTICE.

ALLE IN DIESEM DOKUMENT ENTHALTENEN SCHRIFTLICHEN ANGABEN UND ABBILDUNGEN STELLEN DIE NEUESTEN PRODUKTINFORMATIONEN DAR. WIR BEHALTEN UNS DAS RECHT VOR, JEDERZEIT OHNE VORANKÜNDIGUNG ÄNDERUNGEN VORZUNEHMEN.

LAS FOTOGRAFÍAS E ILUSTRACIONES NO SON VINCULANTES. LOS MATERIALES ESTÁN SUJETOS A CAMBIOS SIN PREVIO AVISO.

KREMLIN - REXSON

150, avenue de Stalingrad

93 245 - STAINS CEDEX - France

☎ : 33 (0)1 49 40 25 25 Fax : 33 (0)1 48 26 07 16

www.kremlin-rexson.com



<p style="text-align: center;">FR</p> <p>Pour une utilisation sûre, il est de votre responsabilité de :</p> <ul style="list-style-type: none"> • Lire attentivement tous les documents contenus dans le CD joint avant la mise en service de l'équipement, • D'installer, d'utiliser, d'entretenir et de réparer l'équipement conformément aux préconisations de KREMLIN REXSON ainsi qu'aux réglementations nationales et/ou locales, • Vous assurez que les utilisateurs de cet équipement ont été formés, ont parfaitement compris les règles de sécurité et qu'ils les appliquent. 	<p style="text-align: center;">UK</p> <p>To ensure safe use of the machinery, it is your responsibility to:</p> <ul style="list-style-type: none"> • Carefully read all documents contained on the enclosed CD before putting the machinery into service, • Install, use, maintain and repair the machinery in accordance with KREMLIN REXSON's recommendations and national and/or local regulations, • Make sure that the users of the machinery have received proper training and that they have perfectly understood the safety rules and apply them. 	<p style="text-align: center;">DE</p> <p>Eine sichere Nutzung setzt voraus, dass Sie: :</p> <ul style="list-style-type: none"> • alle in der CD enthaltenen Dokumente vor der Inbetriebnahme der Anlage aufmerksam lesen, • die Anlage im Einklang mit den Empfehlungen von KREMLIN REXSON sowie mit den nationalen und/oder lokalen Bestimmungen installieren, verwenden, warten und reparieren, • sich vergewissern, dass die Nutzer dieser Anlage angemessen geschult wurden, die Sicherheitsbestimmungen verstanden haben und sie anwenden.
<p style="text-align: center;">ES</p> <p>Para una utilización segura, será de su responsabilidad:</p> <ul style="list-style-type: none"> • leer atentamente todos los documentos que se incluyen en el CD adjunto antes de la puesta en servicio del equipo, • instalar, utilizar, efectuar el mantenimiento y reparar el equipo con arreglo a las recomendaciones de KREMLIN REXSON y a la normativa nacional y/o local, • cerciorarse de que los usuarios de este equipo han recibido la formación necesaria, han entendido perfectamente las normas de seguridad y las aplican. 	<p style="text-align: center;">IT</p> <p>Per un uso sicuro, vi invitiamo a:</p> <ul style="list-style-type: none"> • leggere attentamente tutta la documentazione contenuta nel CD allegato prima della messa in funzione dell'apparecchio, • installare, utilizzare, mantenere e riparare l'apparecchio rispettando le raccomandazioni di KREMLIN REXSON, nonché le normative nazionali e/o locali, • accertarvi che gli utilizzatori dell'apparecchio abbiano ricevuto adeguata formazione, abbiano perfettamente compreso le regole di sicurezza e le applichino. 	<p style="text-align: center;">PT</p> <p>Para uma utilização segura, é da sua responsabilidade:</p> <ul style="list-style-type: none"> • Ler atentamente todos os documentos incluídos no CD em anexo antes de pôr o equipamento em funcionamento, • Proceder à instalação, utilização, manutenção e reparação do equipamento de acordo com as preconizações de KREMLIN REXSON, bem como com outros regulamentos nacionais e/ou locais aplicáveis, • Assegurar-se que os utilizadores do equipamento foram devidamente capacitados, compreenderam perfeitamente e aplicam as devidas regras de segurança.
<p style="text-align: center;">NL</p> <p>Voor een veilig gebruik dient u:</p> <ul style="list-style-type: none"> • alle document op de bijgevoegde cd aandachtig te lezen alvorens het apparaat in werking te stellen, • het apparaat te installeren, gebruiken, onderhouden en repareren volgens de door KREMLIN REXSON gegeven aanbevelingen en overeenkomstig de nationale en/of plaatselijke reglementeringen, • zeker te stellen dat de gebruikers van dit apparaat zijn opgeleid, de veiligheidsregels perfect hebben begrepen en dat zij die ook toepassen. 	<p style="text-align: center;">SE</p> <p>För en säker användning av utrustningen ansvarar ni för följande:</p> <ul style="list-style-type: none"> • Läs noga samtliga dokument som finns på den medföljande cd-skivan innan utrustningen tas i drift. • Installera, använd, underhåll och reparera utrustningen enligt anvisningarna från KREMLIN REXSON och enligt nationella och/eller lokala bestämmelser. • Försäkra er om att användare av denna utrustning erhållit utbildning, till fullo förstått säkerhetsföreskrifterna och tillämpar dem. 	<p style="text-align: center;">FI</p> <p>Käytön turvallisuuden varmistamiseksi velvollisuutesi on:</p> <ul style="list-style-type: none"> • Lukea huolella kaikki CD:llä olevat asiakirjat ennen laitteiston käyttöönottoa, • Noudattaa laitteiston asennuksessa, käytössä, kunnossapidossa ja huollossa KREMLIN REXSON in suosituksia sekä kansallisia ja/tai paikallisia määräyksiä, • Varmistaa, että laitteiston käyttäjät ovat koulutettuja ja ymmärtävät täysin turvallisuusmääräykset ja miten niitä sovelletaan.
<p style="text-align: center;">PL</p> <p>Dla zapewnienia bezpiecznego użytkowania na użytkownika spoczywa obowiązek:</p> <ul style="list-style-type: none"> • Uwważnego zapoznania się ze wszystkimi dokumentami znajdującymi się na załączonej płycie CD przed pierwszym uruchomieniem urządzenia, • Instalowania, użytkowania, konserwacji i naprawy urządzenia zgodnie z zaleceniami firmy KREMLIN REXSON oraz z przepisami miejscowymi, • Upewnienia, że wszyscy przeszkoleni użytkownicy urządzenia zrozumieli zasady bezpieczeństwa i stosują się do nich. 	<p style="text-align: center;">CS</p> <p>Pro bezpečné používání jste povinni:</p> <ul style="list-style-type: none"> • Před uvedením zařízení do provozu si pozorně přečíst veškeré dokumenty obsažené na příloženém CD, • Nainstalovat, používat, udržovat a opravovat zařízení v souladu s pokyny firmy KREMLIN REXSON a s národními a/nebo místními legislativními předpisy, • Ujistit se, že uživatelé tohoto zařízení byli vyškoleni, že dokonale pochopili bezpečnostní pravidla a že je dodržují. 	<p style="text-align: center;">RU</p> <p>Для целей безопасного использования необходимо:</p> <ul style="list-style-type: none"> • Ознакомиться со всеми документами, содержащимися в прилагаемом компакт-диске до ввода оборудования в эксплуатацию; • Устанавливать, использовать, производить техническое обслуживание и ремонт оборудования в соответствии с рекомендациями KREMLIN REXSON и национальным и/или местным законодательством; • Убедиться, что пользователи настоящего оборудования прошли подготовку, надлежащим образом усвоили правила безопасности и обеспечивают их соблюдение.

Déclaration(s) de conformité au verso de ce document / Declaration(s) of conformity at the back of this document / Konformitätserklärung(en) auf der Rückseite dieser Unterlage / Declaración (es) de conformidad en el reverso de este documento / Dichiarazione/i di conformità sul retro del presente documento / Declaração(ões) de conformidade no verso do documento / Conformiteitsverklaring(en) op de keerzijde van dit document / Försäkran om överensstämmelse på omstående sida av detta dokument / Vaatimustenmukaisuusvakuutukset tämän asiakirjan kääntöpuolella / Deklaracja(e) zgodności na odwrocie dokumentu / Prohlášení o shodě se nachází/nacházejí na zadní straně tohoto dokumentu / Сертификат(ы) соответствия расположены на оборотной стороне настоящего документа

VALABLE JUSQU'AU 19 AVRIL 2016
VALID UNTIL 19 APRIL 2016
GÜLTIG BIS ZUM 19. APRIL 2016
VALIDEZ HASTA EL 19 DE ABRIL DE 2016
VALIDO FINO AL 19 APRILE 2016
APLICÁVEL ATÉ 19 DE ABRIL DE 2016
GELDIG TOT 19 APRIL 2016
GÄLLER TILL OCH MED DEN 19 APRIL 2016
VOIMASSA 19.4.2016 SAAKKA
WAŻNOŚĆ DO 19 KWIETNIA 2016 R.
PLATÍ DO 19. DUBNA 2016
ДЕЙСТВИТЕЛЬНО ДО 19 АПРЕЛЯ 2016 ГОДА



DECLARATION CE DE CONFORMITE
EC DECLARATION OF CONFORMITY
EG KONFORMITÄTSERKLÄRUNG
DECLARACIÓN CE DE CONFORMIDAD
DICHIAZIONE CE DI CONFORMITÀ
DECLARAÇÃO CE DE CONFORMIDADE
EG-VERKLARING VAN OVEREENSTEMMING
EG-FÖRSÄKRAN OM ÖVERENSSTÄMMESE
EY-VAATIMUKSEN MUKAISUUSVAKUUTUS
DEKLARACJA ZGODNOŚCI CE
CE PROHLÁŠENÍ O SHODĚ
ДЕКЛАРАЦИЯ СООТВЕТСТВИЯ CE

Le fabricant / The manufacturer / Der Hersteller
/ El fabricante / Il produttore / O fabricante
/ De fabrikant / Tillverkare / Valmistaja / Producent / Výrobce
/ Изготовитель:

KREMLIN REXSON
150, avenue de Stalingrad
93 240 - STAINS - FRANCE
Tél. 33 (0)1 49 40 25 25 - Fax : 33 (0)1 48 26 07 16

Déclare que le matériel désigné ci-après / Herewith declares that the equipment / erklärt hiermit, dass die / Declara que el material designado a continuación / Dichiaro che il materiale sottoindicato / Declara que o material a seguir designado / verklaart dat de hieronder aangeduide apparatuur / Kungör att den utrustning som anges här nedan / ilmoittaa, että alla mainitut laitteistot / Oświadczka, że wymienione poniżej urządzenia / Prohlašuje, že níže uvedené vybavení / Декларирует, что ниженазванное оборудование:

**PISTOLET MANUEL DE PULVERISATION AIRMIX® / AIRMIX® MANUAL SPRAYING GUN
DIE AIRMIX® HAND-SPRITZPISTOLE / PISTOLA MANUAL DE PULVERIZACIÓN AIRMIX®**

Xcite™

Est conforme à la législation d'harmonisation de l'Union applicable suivante / Is in conformity with the relevant Union harmonisation legislation / Erfüllt die einschlägigen Harmonisierungsrechtsvorschriften der Union / es conforme con la legislación de armonización pertinente de la Unión / è conforme alla pertinente normativa di armonizzazione dell'Unione / in overeenstemming met de desbetreffende harmonisatiewetgeving van de Unie / med den relevanta harmoniserade unionslagstifningen / on asiaa koskevan unionin yhdenmukaistamislainsäädännön vaatimusten mukainen / jest zgodny z odpowiednimi wymaganiami unijnego prawodawstwa harmonizacyjnego / Shoduje se s následující příslušnou evropskou harmonizační legislativou / Соответствует следующим стандартизированным нормам Союза

Directive ATEX / ATEX Directive / ATEX Richtlinie / Directiva ATEX / Direttiva ATEX / Diretiva ATEX
/ ATEX-Richtlijn / ATEX-direktivet / ATEX-direktivi / Dyrektywa ATEX / Směrnice ATEX / Директива ATEX



94/9/CE

Dominique LAGOUGE

Directeur Général / Chief Executive Officer / Generaldirektor
/ Director General / Direttore Generale / Director Geral / Algemeen
Directeur / Generaldirektör / Pääjohtaja / Dyrektor Naczelny
/ Dyrektor Generalny / Generální ředitel / Генеральный директор

Fait à Stains, le / Established in Stains, on / Geschehen zu Stains, am / En Stains, a / Redatto a Stains, / Vastgesteld te Stains, / Utformat i Stains, den / Stains, Ranska, / Sporządzono w Stains, dnia / Stains, dnia / Издано в г. Стен (Stains) 02/02/2010 - 02/02/2010

VALABLE A PARTIR DU 20 AVRIL 2016
VALID FROM 20 APRIL 2016
GÜLTIG AB DEM 20. APRIL 2016
VALIDEZ A PARTIR DEL 20 DE ABRIL DE 2016
VALIDO A PARTIRE DAL 20 APRILE 2016
APLICÁVEL A PARTIR DE 20 DE ABRIL DE 2016
GELDIG VANAF 20 APRIL 2016.
GÄLLER FRÅN OCH MED DEN 20 APRIL 2016
VOIMASSA 20.4.2016 ALKAEN
WAŻNOŚĆ OD 20 KWIETNIA 2016 R.
PLATÍ OD 20. DUBNA 2016
ДЕЙСТВИТЕЛЬНО С 20 АПРЕЛЯ 2016 ГОДА



DECLARATION UE DE CONFORMITE
UE DECLARATION OF CONFORMITY
EU- KONFORMITÄTSEKLRÄRUNG
DECLARACIÓN UE DE CONFORMIDAD
DICHIAZIONE DI CONFORMITÀ UE
DECLARAÇÃO UE DE CONFORMIDADE
EU-CONFORMITEITSVERKLARING
EU-FÖRSÄKRAN OM ÖVERENSSTÄMMELSE
EU- VAATIMUKSEN MUKAISUUSVAKUUTUS
DEKLARACJA ZGODNOŚCI UE
EU PROHLÁŠENÍ O SHODĚ
ДЕКЛАРАЦИЯ О СООТВЕТСТВИИ НОРМАМ ЕС

Le fabricant / The manufacturer / Der Hersteller / El fabricante / Il produttore / O fabricante / De fabrikant / Tillverkare / Valmistaja / Producent / Výrobce / Изготовитель:	KREMLIN REXSON 150, avenue de Stalingrad 93 240 - STAINS - FRANCE Tél. 33 (0)1 49 40 25 25 - Fax : 33 (0)1 48 26 07 16
--	--

Déclare que le matériel désigné ci-après / Herewith declares that the equipment / erklärt hiermit, dass die / Declara que el material designado a continuación / Dichiara che il materiale sottoiducato / Declara que o material a seguir designado / verklaart dat de hieronder aangeduide apparatuur / Kungör att den utrustning som anges här nedan / ilmoittaa, että alla mainitut laitteistot / Oświadczka, że wymienione poniżej urządzenia / Prohlašuje, že níže uvedené vybavení / Декларирует, что ниженазванное оборудование:

PISTOLET MANUEL DE PULVERISATION AIRMIX® / AIRMIX® MANUAL SPRAYING GUN
DIE AIRMIX® HAND-SPRITZPISTOLE / PISTOLA MANUAL DE PULVERIZACIÓN AIRMIX®

Xcite™ 120
Xcite™ 200
Xcite™ 400

Est conforme à la législation d'harmonisation de l'Union applicable suivante / Is in conformity with the relevant Union harmonisation legislation / Erfüllt die einschlägigen Harmonisierungsrechtsvorschriften der Union / es conforme con la legislación de armonización pertinente de la Unión / è conforme alla pertinente normativa di armonizzazione dell'Unione / in overeenstemming met de desbetteffende harmonisatiewetgeving van de Unie / med den relevanta harmoniserade unionslagstiftningen / on asiaa koskevan unionin yhdenmukaistamislainsäädännön vaatimusten mukainen / jest zgodny z odnośnymi wymaganiami unijnego prawodawstwa harmonizacyjnego / Shoduje se s následující příslušnou evropskou harmonizační legislativou / Соответствует следующим стандартизированным нормам Союза

Directive ATEX / ATEX Directive / ATEX Richtlinie / Directiva ATEX / Direttiva ATEX / Diretiva ATEX / ATEX-Richtlijn / ATEX-direktivet / ATEX-direktivi / Dyrektywa ATEX / Směrnice ATEX / Директива ATEX 	2014/34/UE
Procédure d'évaluation de la conformité : Module A Documentation technique (Annexe VIII) archivée par : / Conformity assessment procedure: Module A Technical documentation (ANNEX VIII) recorded by: / Verfahren zur Konformitätsbewertung: Modul A Technische Unterlagen (ANLAGE VIII) archiviert durch: / Procedimiento de evaluación de la conformidad: Módulo A Documentación técnica (ANEXO VIII) archivada por: / Procedura di valutazione della conformità: Modulo A Documentazione tecnica (ALLEGATO VIII) archiviata a cura di: / Procedimento de avaliação da conformidade: Módulo A Documentação técnica (ANEXO VIII) arquivada por: / Conformiteitsbeoordelingsprocedure: Module A Technische documentatie (BIJLAGE VIII) gearhiveerd door: / Förfarande för bedömning av överensstämmelse: Modul A Teknisk dokumentation (BILAGA VIII) arkiverad av: / Vaatimustenmukaisuusarviointimenetelmä: moduuli A Tekninen dokumentaatio (LIITE VIII) arkistoitu: / Procedura oceny zgodności: Moduł A Dokumentacji technicznej (ZAŁĄCZNIK VIII) zarchiwizowane przez: / Postup posuzování shody: Modul A Technická dokumentace (PŘÍLOHA VIII) archivována: / Процедура оценки соответствия: Модуль A Техническая документация (ПРИЛОЖЕНИЕ VIII), архивированная: ISSeP Zoning A. Schweitzer Rue de la Platinerie B - 7340 COLFONTAINE BELGIQUE	

Dominique LAGOUGE
 Directeur Général / Chief Executive Officer / Generaldirektor
 / Director General / Direttore Generale / Director Geral / Algemeen
 Directeur / Generaldirektör / Pääjohtaja / Dyrektor Naczelny
 / Dyrektor Generalny / Generální ředitel / Генеральный директор

Fait à Stains, le / Established in Stains, on / Geschehen zu Stains, am / En Stains, a / Redatto a Stains, / Vastgesteld te Stains, / Utformat i Stains, den / Stains, Ranska, / Sporządzono w Stains, dnia / Stains, dnia / Издано в г. Стен (Stains) 04/04/2016 - 04/04/2016



INSTALLATION AND SAFETY INSTRUCTIONS

TRANSLATION OF THE ORIGINAL MANUAL

IMPORTANT : Before assembly and start-up, please read and clearly understand all the documents relating to this equipment (professional use only).

THE PICTURES AND DRAWINGS ARE NON CONTRACTUAL. WE RESERVE THE RIGHT TO MAKE CHANGES WITHOUT PRIOR NOTICE.

KREMLIN - REXSON
150, avenue de Stalingrad
93 245 - STAINS CEDEX – France
☎ : 33 (0)1 49 40 25 25 Fax : 33 (0)1 48 26 07 16

www.kremlin-rexson.com

1. SAFETY INSTRUCTIONS

GENERAL SAFETY INSTRUCTIONS



CAUTION : The equipment can be dangerous if you do not follow our instructions concerning installation and servicing described in this manual and in accordance with applicable European standards and local national safety regulations.

Please carefully read all the instruction literature before operating your equipment.

Only trained operators can use the equipment (To acquire an essential training, please contact the "KREMLIN REXSON University" training center - Stains).

The foreman must ensure that the operator has understood the safety instructions for this equipment as well as the instructions in the manuals for the different parts and accessories.

Read carefully all instruction manuals, label markings before operating the equipment.



















Incorrect use may result in injury. This equipment is for professional use only. It must be used only for what it has been designed for. Never modify the equipment. The parts and accessories supplied must be regularly inspected. Defective or worn parts must be replaced.

Guards (motor cover, coupling shields, connectors,...) have been designed for a safe use of the equipment.
The manufacturer will not be held responsible for bodily injury or failure and / or property damage due to destruction, the overshadowing or the partial or total removal of the guards.

Never exceed the equipment components' maximum working pressure.

Comply with regulations concerning safety, fire risks, electrical regulations in force in the country of final destination of the material. Use only products or solvent compatible with the parts in contact with the material (refer to data sheet of the material manufacturer).

PICTOGRAMS

					
NIP HAZARD	WARNING MOVING ELEVATOR	WARNING MOVING PARTS	WARNING MOVING SHOVEL	DO NOT EXCEED THIS PRESSURE	HIGH PRESSURE HAZARD
					
RELIEF OR DRAIN VALVE	WARNING HOSE UNDER PRESSURE	WEAR GLASSES OBLIGATORY	WEAR OF GLOVES IS OBLIGATORY	PRODUCT VAPOR HAZARDS	WARNING HOT PARTS OR AREAS
					
ELECTRICAL HAZARD	WARNING FIRE HAZARDS	EXPLOSION HAZARDS	GROUNDING	WARNING (USER)	WARNING SERIOUS INJURIES

FIRE - EXPLOSION - SPARKS - STATIC ELECTRICITY HAZARDS

A poor earth connection, inadequate ventilation, sparks or static electricity can cause an explosion or fire. To avoid these risks when using or servicing KREMLIN REXSON equipment, the following safety procedures must be followed :



- ensure a good earth connection and ground the parts to be handled i.e. solvents, materials, components and equipment,
- ensure adequate ventilation,
- keep working area clean and free from waste solvents, chemicals, or solid waste i.e. rags, paper and empty chemicals drums,
- never use electrical switches / power if in an atmosphere of volatile solvent vapour,
- stop working immediately in case of electrical arcs,
- never store chemicals and solvents in the working area.
- use paint whose flash point is the highest possible to prevent from any formation of gas and inflammable vapours (refer to materials' safety instructions),
- install a cover on the drums to reduce the diffusion of gas and vapours in the spraybooth.

TOXIC PRODUCT HAZARDS

Toxic products or vapours can cause severe injury not only through contact with the body, but also if the products are ingested or inhaled. It is imperative :



- to know the material products and their risks,
- notified or hazardous materials must be stored in accordance with the regulations,
- the material must be stored in an appropriate container, never place materials in a container where there is a risk of spillage or leakage,
- a procedure must be applied for the safe disposal of waste material. It must comply with all prevailing regulations and legislations of the country where the equipment is to be used,
- protective clothing should always be worn in compliance with the material manufacturers' recommendations,
- depending on the application and chemical safety instructions, safety glasses, hearing protective earplug, gloves, foot wear, protective masks and possible breathing equipment should be worn to comply with the regulations (Refer to chapter "Safety equipment of KREMLIN selection guide).



CAUTION!



It is forbidden to use material containing high concentrations of halogenated hydrocarbon solvents with **aluminium** or **zinc fillers**. Non-compliance with the instructions may cause explosion risk causing serious or fatal injury.

EQUIPMENT REQUIREMENTS

Guards (motor cover, coupling shields, connectors,...) have been designed for a safe use of the equipment.

The manufacturer will not be held responsible for bodily injury or failure and / or property damage due to destruction, the overshadowing or the partial or total removal of the guards.

PUMP



Before carrying out any work, it is imperative to read and clearly understand the disassembly and reassembly instructions before servicing. The operator must understand the equipment and the safety instructions. These instructions are available in the equipment manuals.



The air motor is designed to be mounted with a pump. Never modify any components or couplings. When operating, please keep hands away from moving parts. Before starting up the equipment, please read the PRESSURE RELIEF instructions. Please ensure that any relief or drain valves fitted are in good working order.

HOSES

- Keep hoses out of circulation areas, moving parts or hot surfaces,
- Never expose product hoses to temperature higher than + 60°C / 140° F or lower than 0°C / 32° F,
- Never pull or use the hoses to move the equipment,
- Tighten all fittings as well as the hoses before operating the equipment,
- Check the hoses regularly; change them if they are damaged,
- Never exceed the working pressure (WP) indicated on the hose.

USED PRODUCTS

Considering the wide variety of products that are available and can be used in our equipment it is impossible to check and make recommendations for all chemical data, regarding the risks of possible chemical attack and their long term chemical reaction

KREMLIN REXSON can not be held liable for :

- Compatibility of wetted parts,
- Risks to staff and the surroundings,
- for worn or defective parts, for faulty equipment or units, or the quality of final product.

It is the responsibility of the user to know and prevent any possible risks such as toxic vapours, fires or explosions. He shall determine the risks of immediate reactions or pursuant to repeated exposures of the staff,

KREMLIN REXSON shall not be liable for physical injuries, direct or indirect material damages caused by the use of chemicals.

2. HANDLING

 **Check the weight and the dimensions of the equipment**
(🔗 refer to 'Technical features' section of the instruction manual)

If weight and dimensions are too important, the unloading must be carried out by means of a forklift or any other appropriate means with a qualified personnel and in a clear horizontal area to prevent from risks of damage injury or an accident.

The centre of gravity is not in the centre of the machine : carry out by hand a stability-test after having lifted the whole at 10 cm / 3.937" maximum.

After the unloading, the handling of the whole (eg: elevator pump) is carried out by means of a pallet truck taking the bottom part of the frame.

Remark : Each pump motor is fitted with a ring. The ring is designed for the hoisting of one pump and can not be used for the handling of the complete machine.

3. STORING

Storing before installation :

- Storing ambient temperature : 0 / +50 °C / 0 / +122°F
- Protect the whole against dust, water trickling, dampness and shocks.

Storing after installation :

- Operating temperature : +15 / +35 °C / +59 / +138.2° F
- Protect the whole against dust, water trickling, dampness and shocks.

4. INSTALLATION OF THE EQUIPMENT

The machine is installed on a stable horizontal floor (for eg a concrete flag).



To avoid risks caused by static electricity, the equipment as well as its components must be grounded.

- **For the pumping equipments** (pumps, pneumatic rams, frame...), a section wire of 2.5 mm² is fixed on the material. Use this wire to connect the material to "the general ground". In case of severe environments (mechanical protection of the wire of earthing insufficient, vibrations, mobile material...) where function damages at the ground are probable, the user have to replace the provided wire of 2.5 mm² by a device more adapted to its environment (wire with a more important section, bonding strip, fixing by thimble with eyelet...),

The continuity of the ground must be controlled by a qualified electrician. If the continuity of the ground is not ensured, check the terminal, the wire and the earthing point. **Never** use the material without have solved this problem.

- In the severe cases of environments (mechanical protection of the wire of earthing insufficient, vibrations, mobile material...) where damages of the function put at the ground are probable, the user will have to replace the wire of 2.5 mm² provided, by a device more adapted to its environment (wire of more important section, bonding strip, fixing by thimble with eyelet...),
- **The gun** must be 'grounded' via a material hose or an air hose. In case of spraying by means of a gun with cup, the air hose must be conductive,
- **The materials to be painted** must also be grounded.

All the materials situated in the working area shall be grounded.



- **Never store** more than necessary inflammable materials inside the working area,
- The materials must be stored into **approved drums** and grounded,
- Use only grounded **metals containers** for the use of cleaning solvents,
- **Cardboard and paper are prohibited.**

5. MARKING OF THE EQUIPMENT

Each equipment has a marking plate.

The plate consists of the name of the manufacturer, the equipment part number and important information for correct use of the equipment (air pressure, electric power,...).



SPECIFIC SAFETY INSTRUCTIONS

Airmix® Gun

TRANSLATION OF THE ORIGINAL DOCUMENT

IMPORTANT : before assembly and start-up, Please read and clearly understand all documents relating to this equipment (professional use only).

PICTURES AND DRAWINGS ARE NON CONTRACTUAL. WE RESERVE THE RIGHT TO MAKE CHANGES WITHOUT PRIOR NOTICE.

KREMLIN - REXSON

150, avenue de Stalingrad

93 245 - STAINS CEDEX – France

☎ : 33 (0)1 49 40 25 25 Fax : 33 (0)1 48 26 07 16

www.kremlin-rexson.com

■ SPECIFIC SAFETY INSTRUCTIONS



Install a conductive fluid hose or a conductive air hose on the Airmix® gun to ground the gun.



Never exceed the maximum operating pressures of the equipment components.



Always depressurize air and hoses before carrying out any servicing on the gun.



Never wipe the end of the nozzle with the fingers.

Never point the spray gun at anyone or at any part of the body.

Always use the safety trigger lock when leaving the gun unattended.



Always use the equipment in a well ventilated area to protect health and to minimise the risks from fire and explosions.



To protect the operator, protective clothing (gloves, respirator mask, glasses, clothes...) are required.

■ GENERAL SAFETY INSTRUCTIONS



CAUTION : The equipment can be dangerous if not used in accordance to the rules mentioned in this instruction manual. Please ensure you carefully read all the instructions before operating your equipment.

Only trained operators can use the equipment (To acquire the essential training, please contact the "KREMLIN REXSON University" training center - Stains).

The foreman must ensure that the operator has perfectly understood the safety instructions for this equipment as well as the instructions in the manuals for the different parts and accessories.

Read carefully all instruction manuals, label markings before operating the equipment.

Comply with regulations concerning safety, fire risks, electrical supply and Voltage in force in the country of final destination of the equipment.



 **Refer to the document
"Installation and safety instructions"**



**DEMONTAGE / REMONTAGE
DISASSEMBLY / REASSEMBLY
DEMONTAGE / MONTAGE
DESMONTAJE / MONTAJE**

XCITE™

**NOTICE ORIGINALE
/ TRANSLATION OF THE ORIGINAL MANUAL
/ ÜBERSETZUNG DER ORIGINAL BEDIENUNGSANLEITUNG
/ TRADUCCIÓN DEL LIBRO ORIGINAL**

**Le pistolet est soumis à la directive ATEX et ne doit en aucun cas être modifié.
Le non-respect de cette préconisation ne saurait engager notre responsabilité.
/ The gun is manufactured under the ATEX agreement and can not be modified.
KREMLIN REXSON will not be held responsible for any failure to comply with that
instruction.**

**/ Der Pistole hat die ATEX Zulassung, deswegen darf die Maschine nie geändert werden.
Die Nichtbeachtung dieser Präkonisation könnte unsere Verantwortung nicht
übernehmen.**

**/ La pistola es de conformidad a la directiva ATEX y no debe ser modificada, en ningún
caso. KREMLIN REXSON no se hace responsable de que esta preconización no sea
respetada.**

**Vous aurez besoin de / You need
Werkzeugaufstellung / Vd necesita**



120 bar / 1740 psi & 200 bar / 2900 psi

↻ 3 - 13

400 bar / 5800 psi

↻ 14 - 25

1

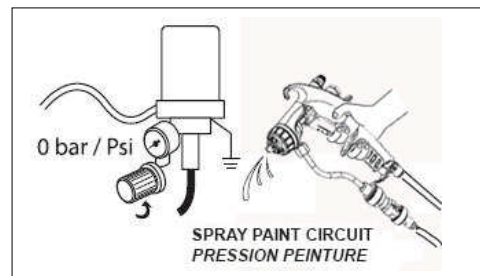
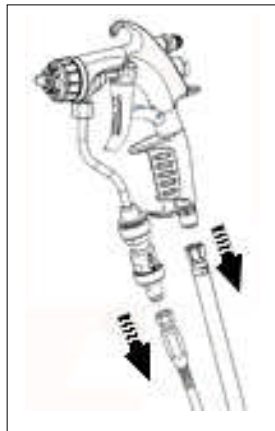
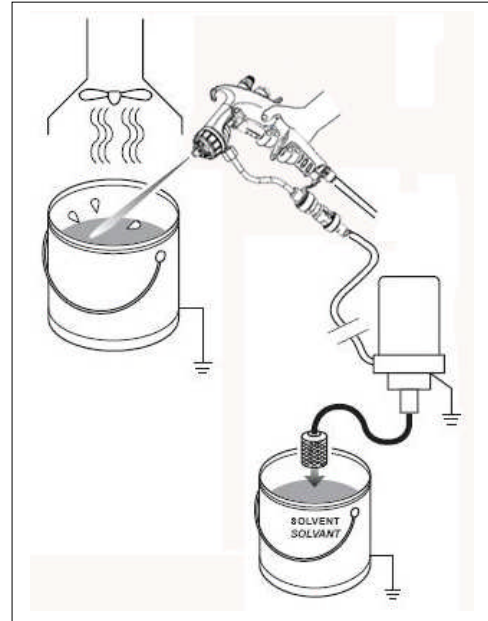
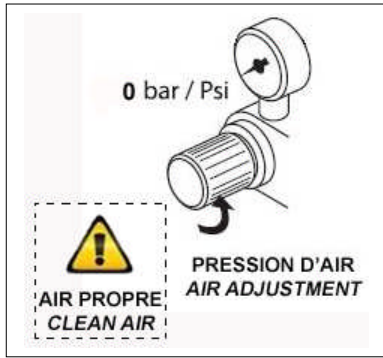

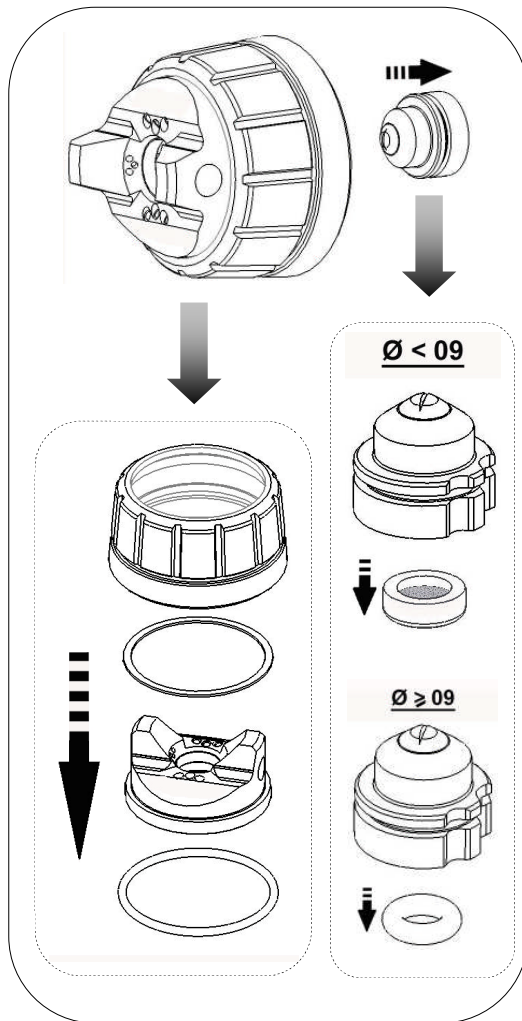
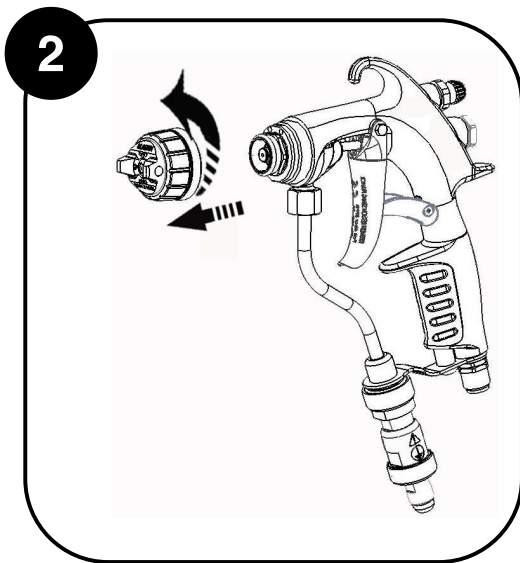
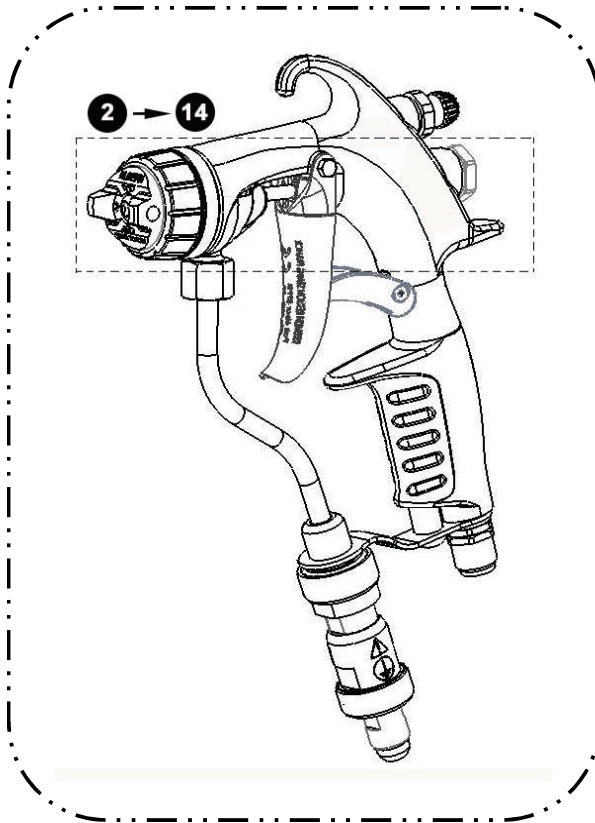

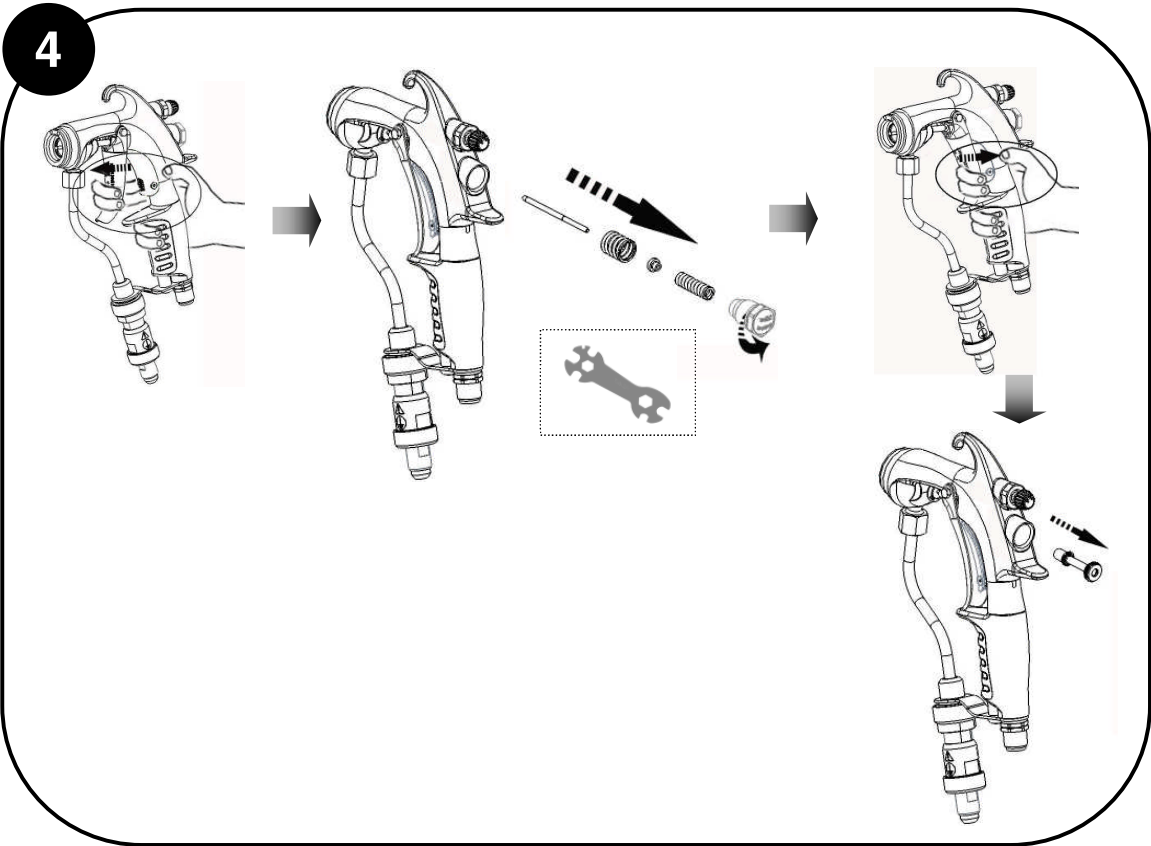
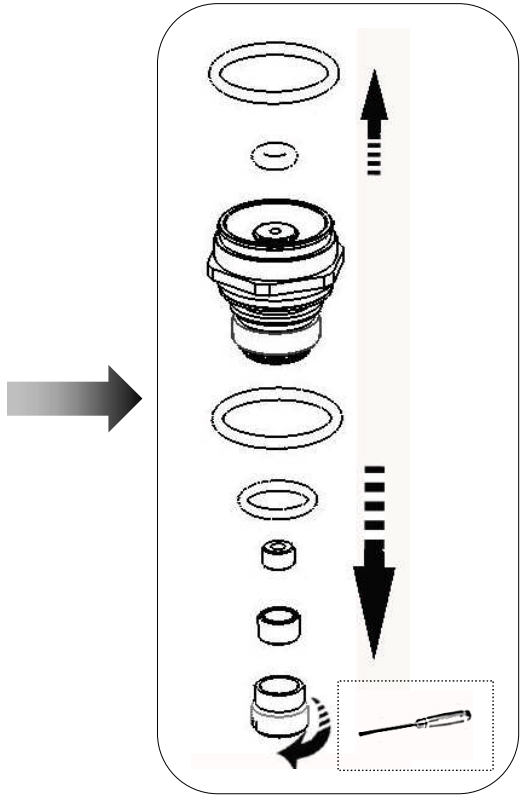
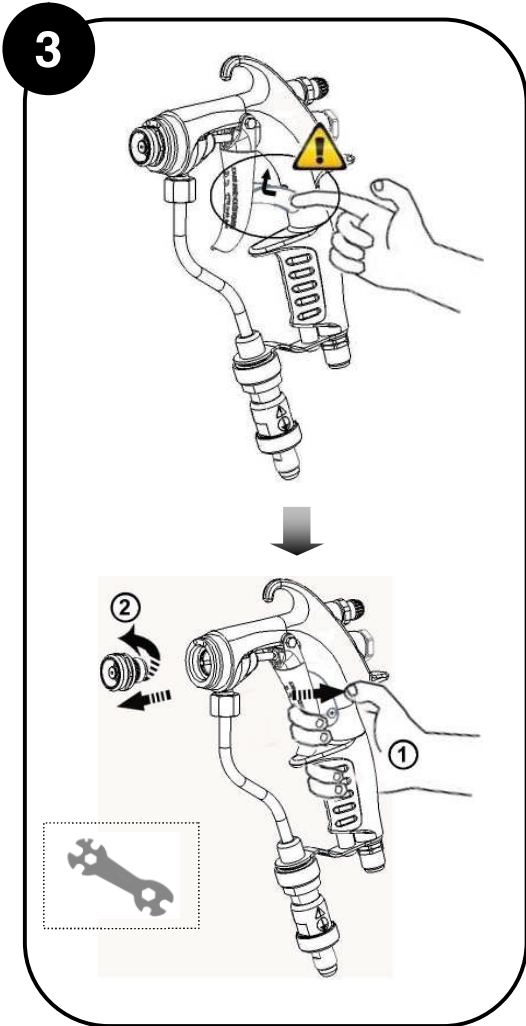

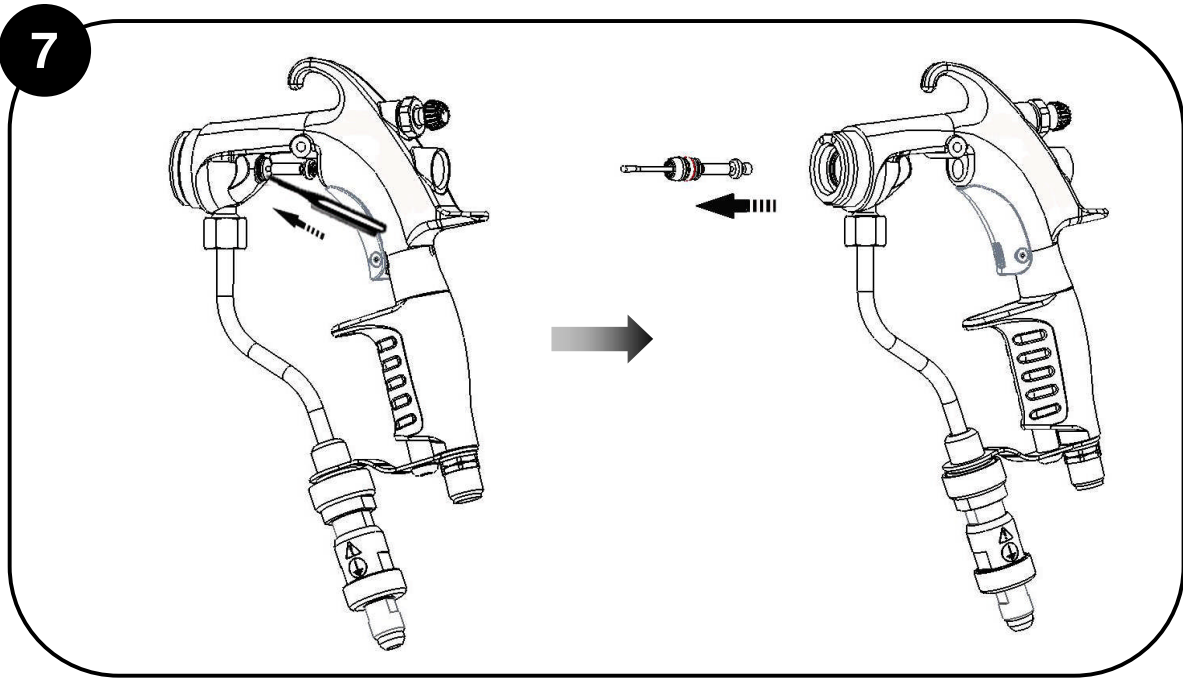
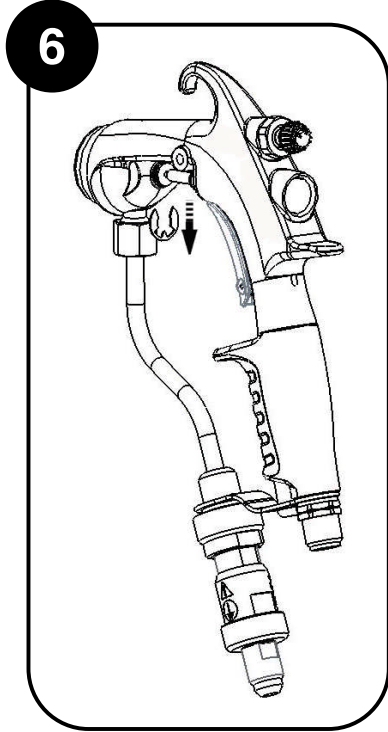
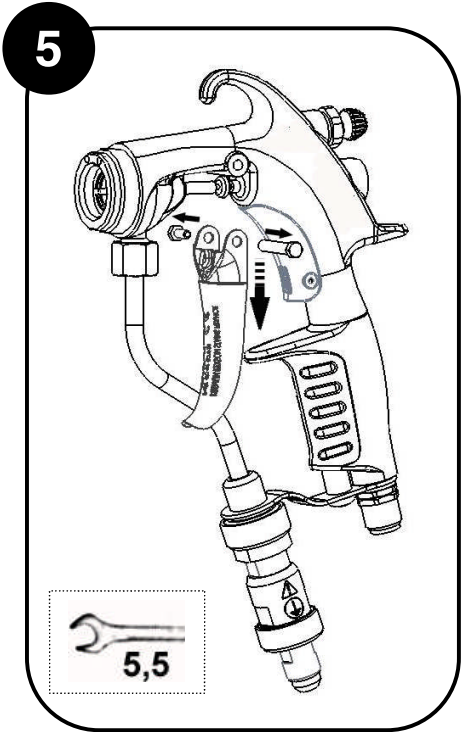

12

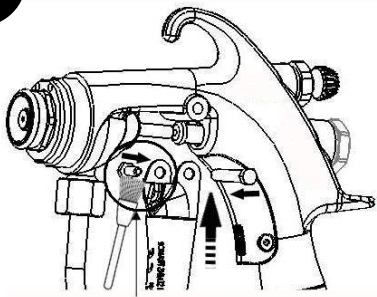

Colle Anaérobie frein filet faible
 Low strength - Anaerobic Adhesive

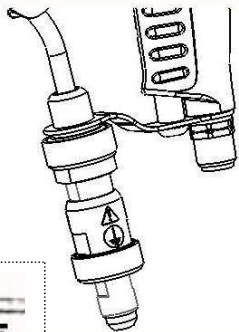

5,5

13

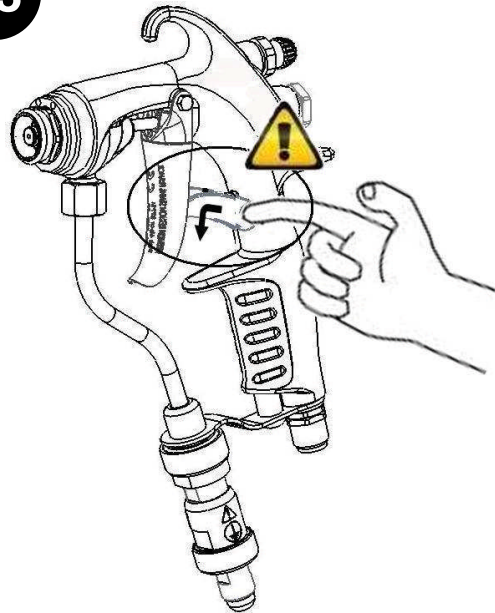

14

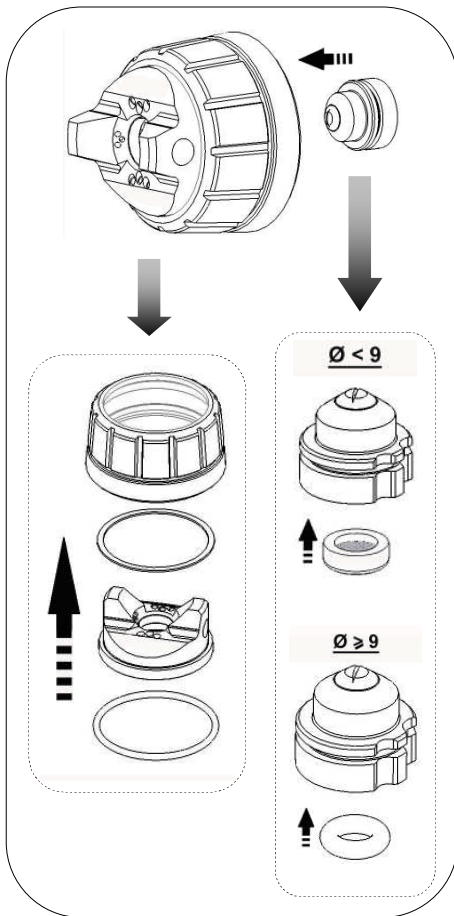
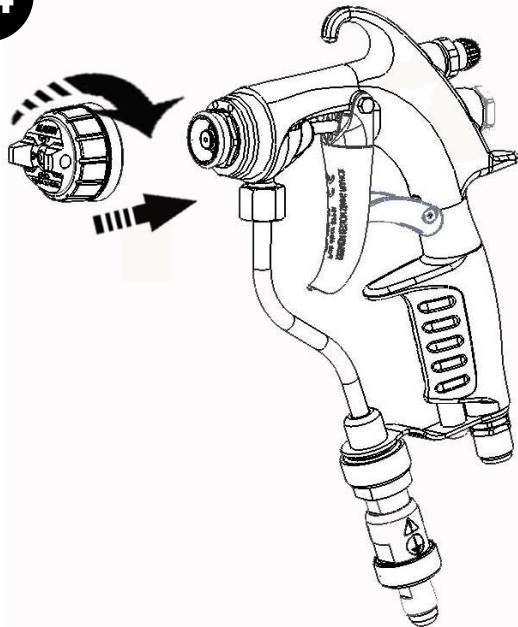

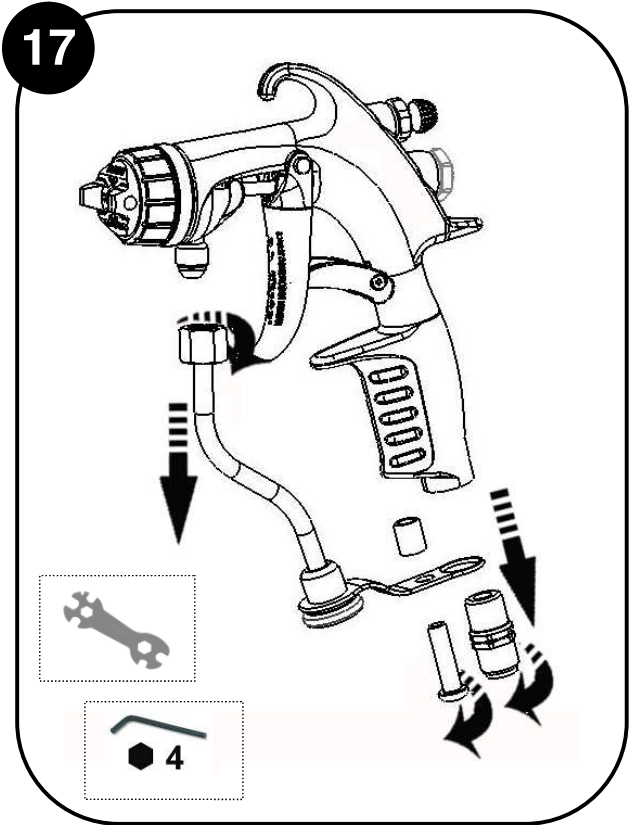
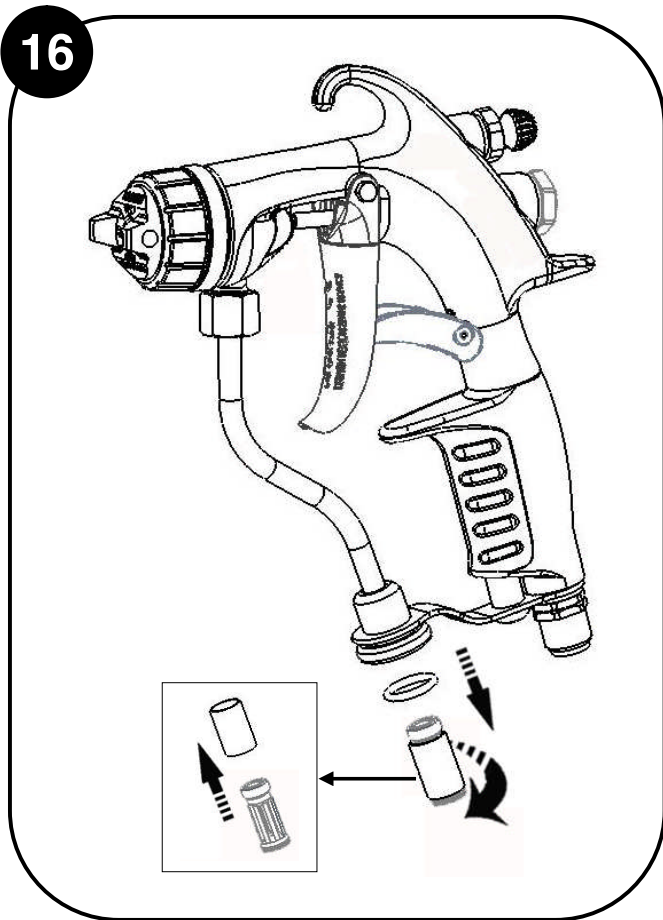
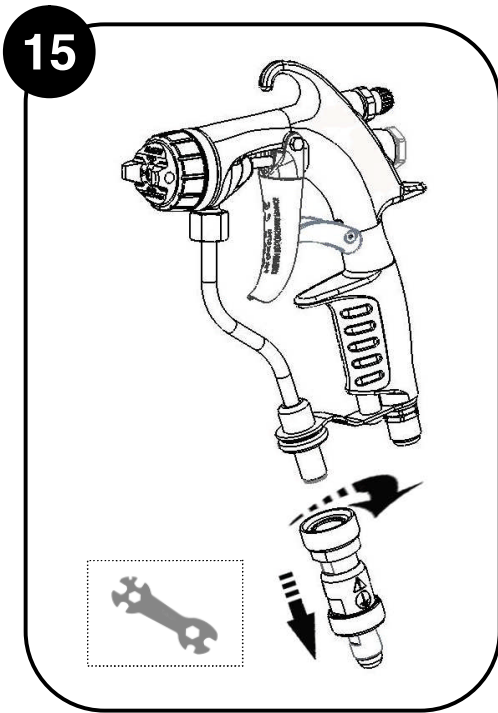
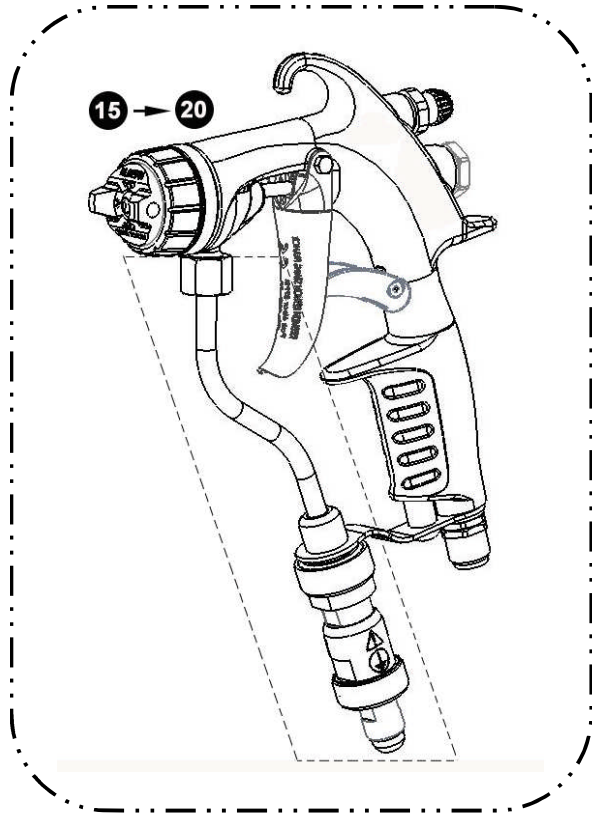

18

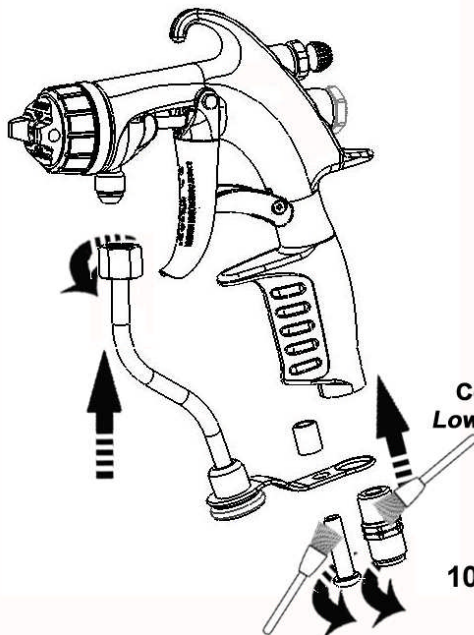

Colle Anaérobie frein filet faible
Low strength - Anaerobic Adhesive

10 N.m - 7.4 Ft/Lbs

Colle Anaérobie frein filet faible
Low strength - Anaerobic Adhesive

19

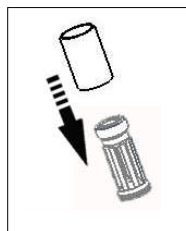
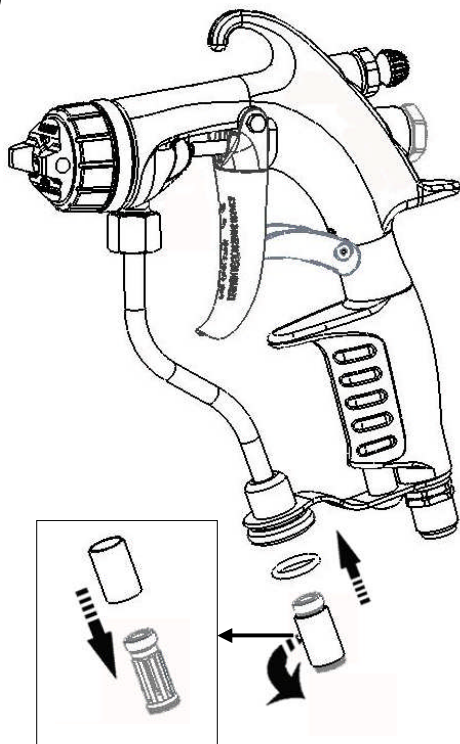

20

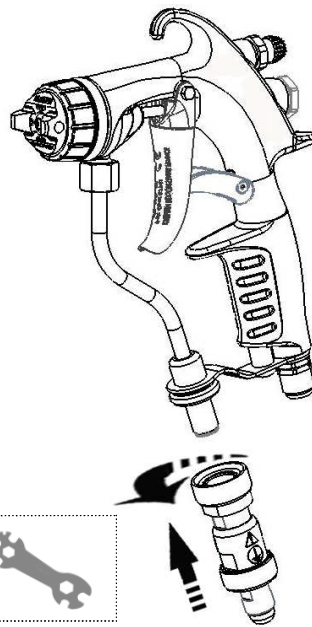

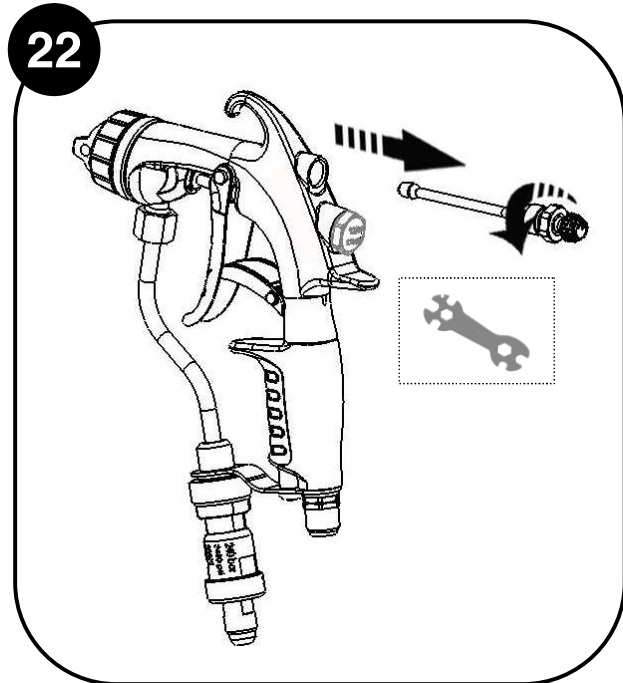
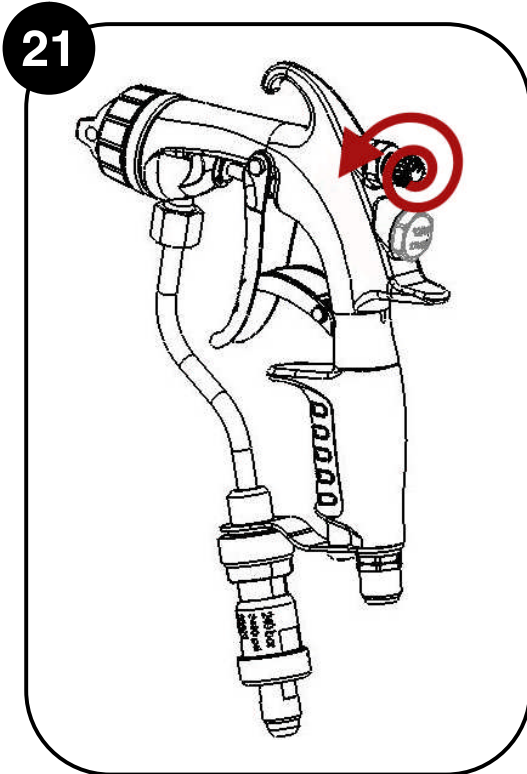
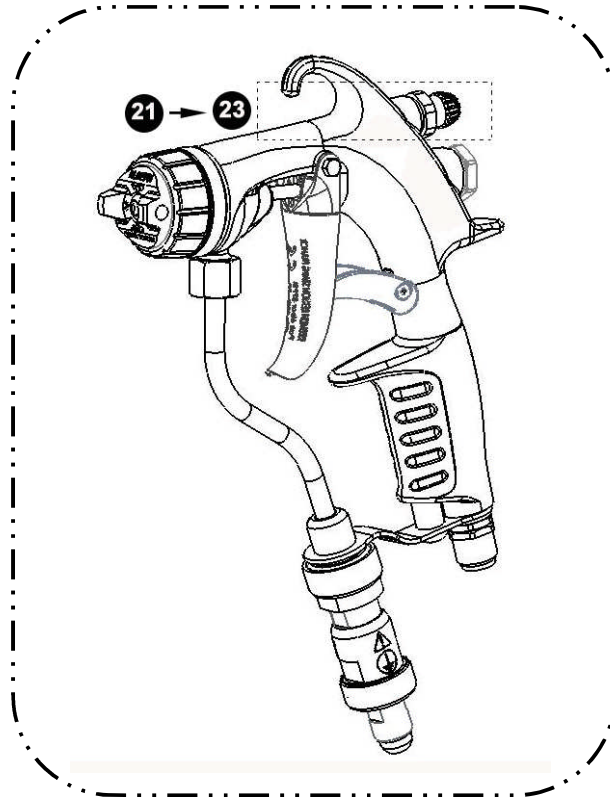

23

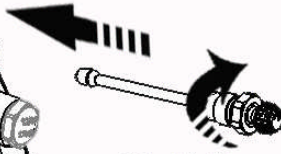
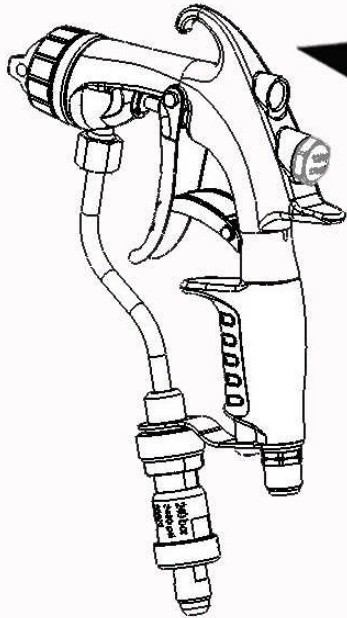

10-11 N.m - 7.4 - 8.1 Ft/Lbs

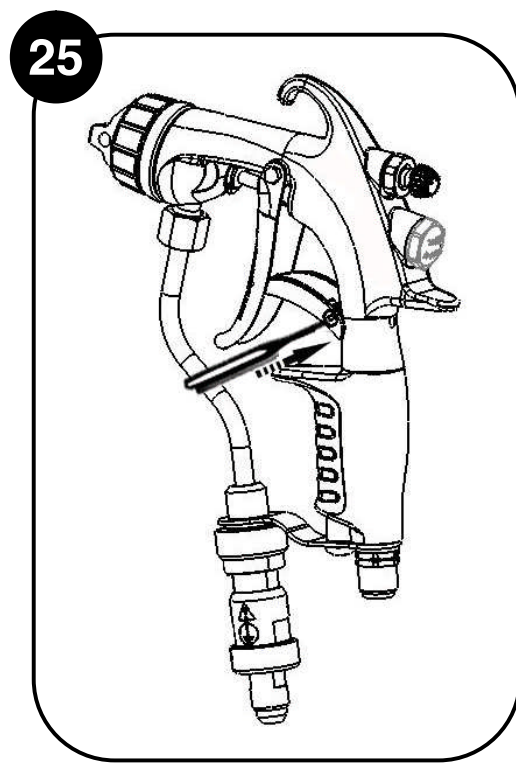
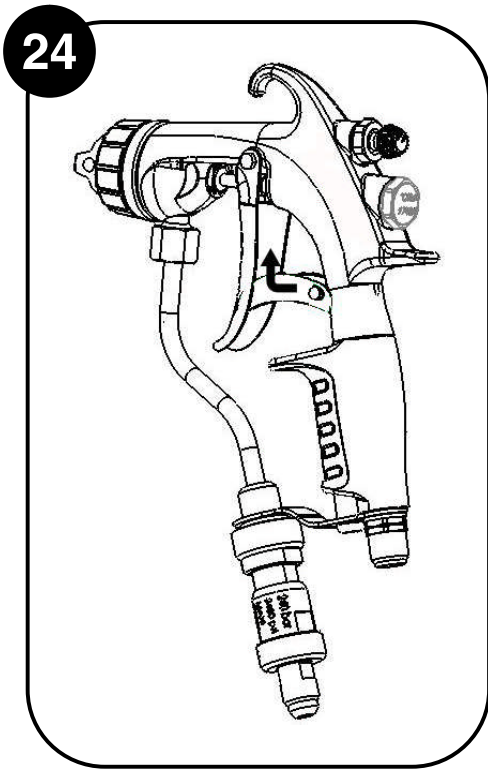
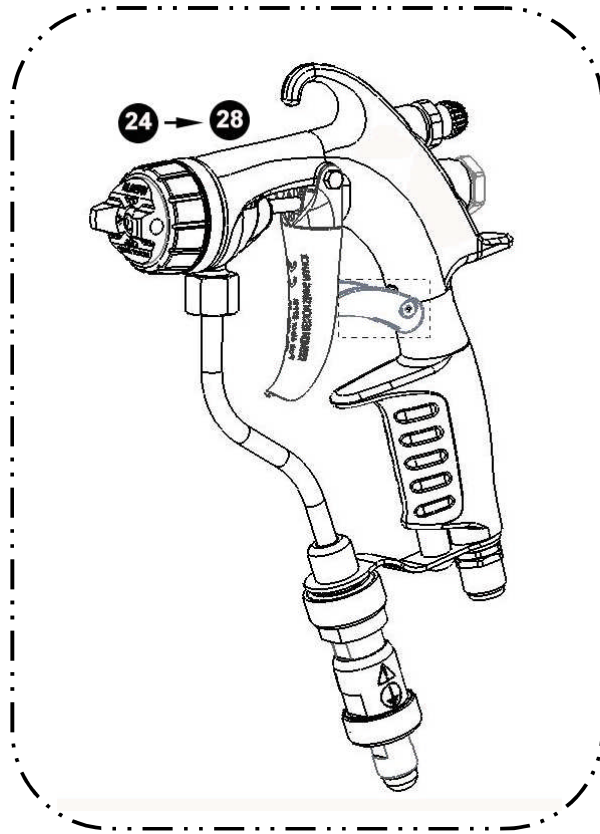

26

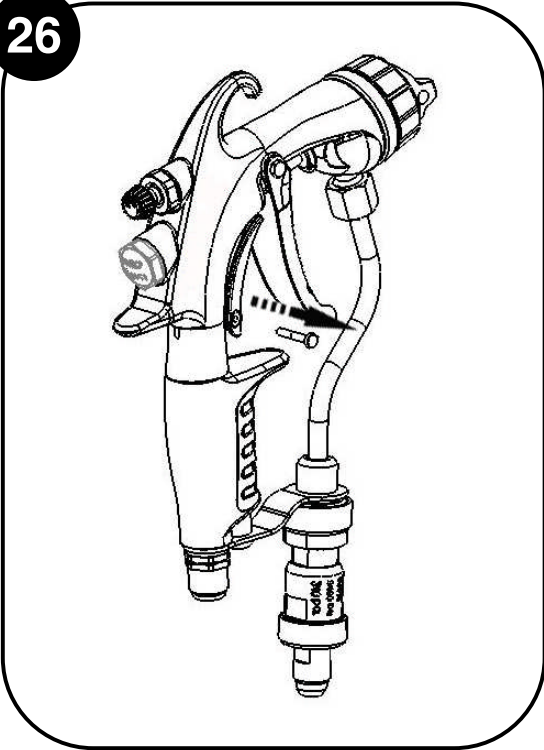

27

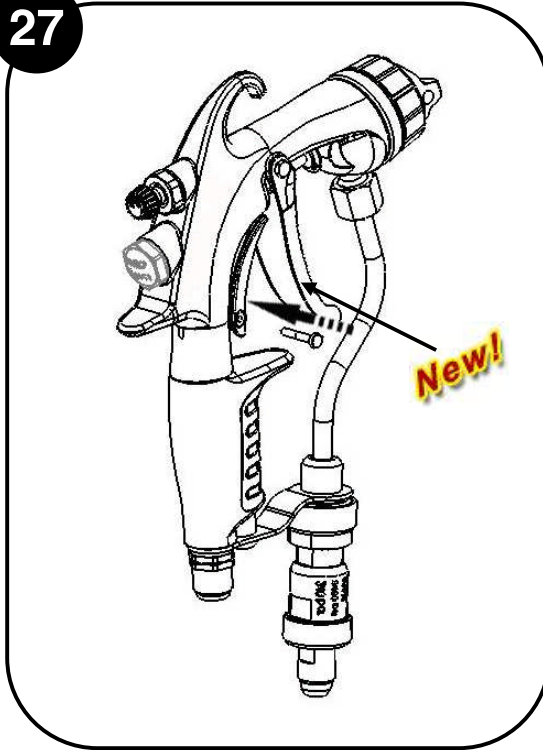

28

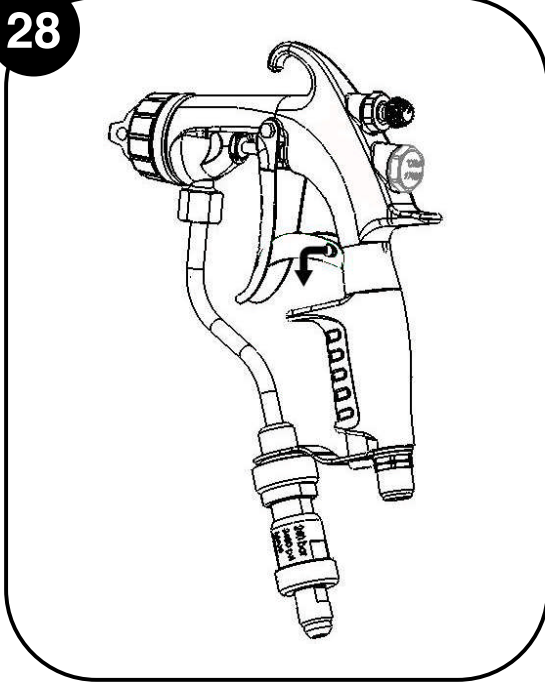

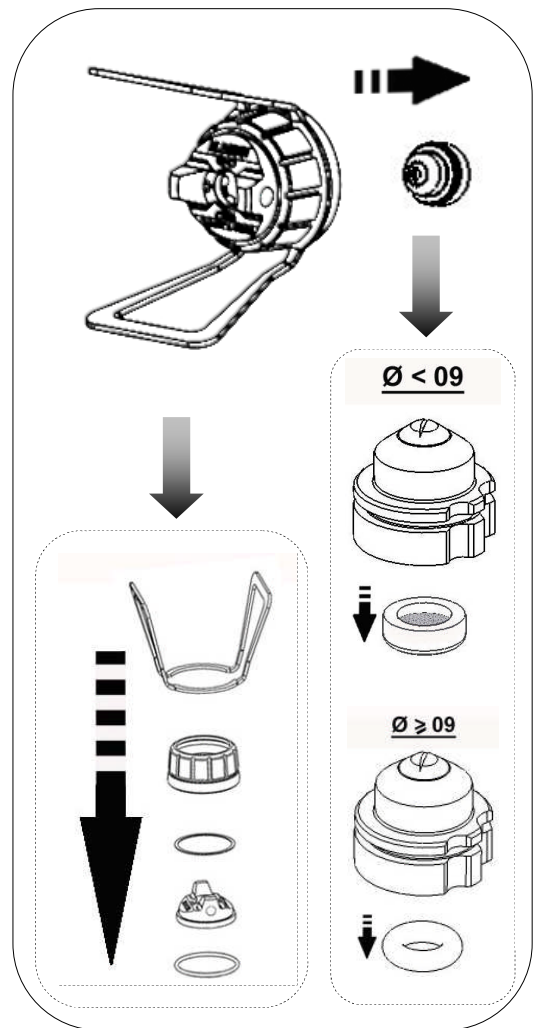
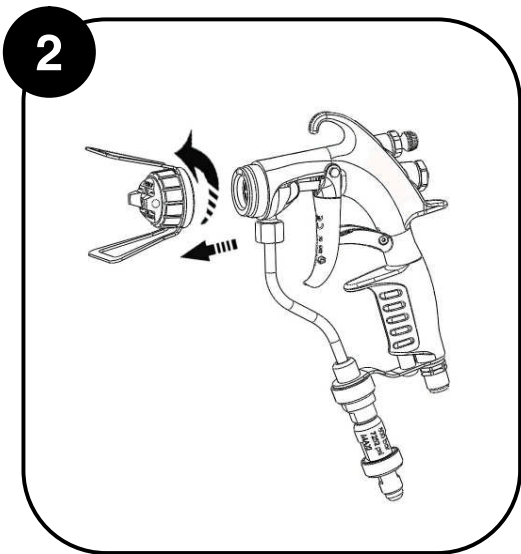
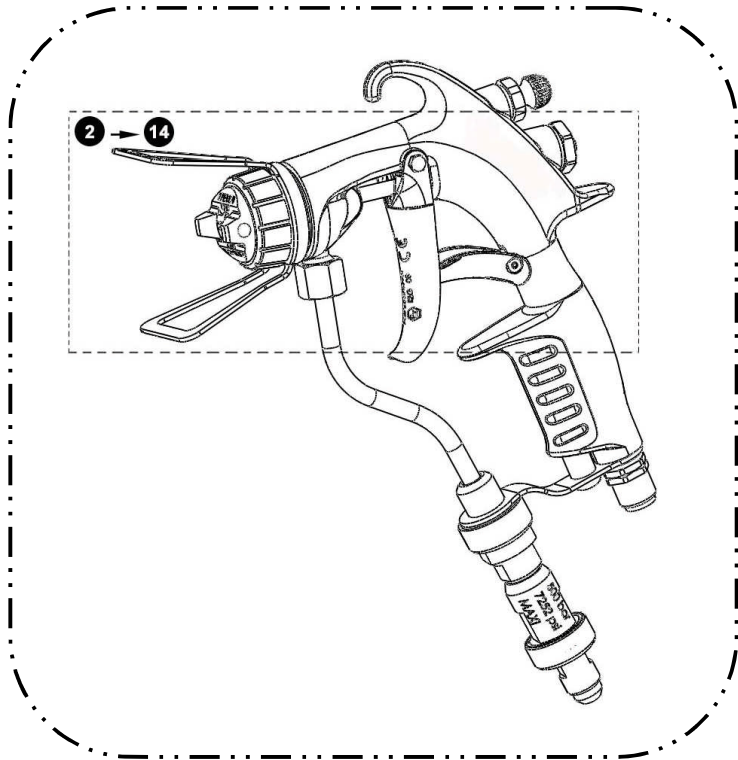

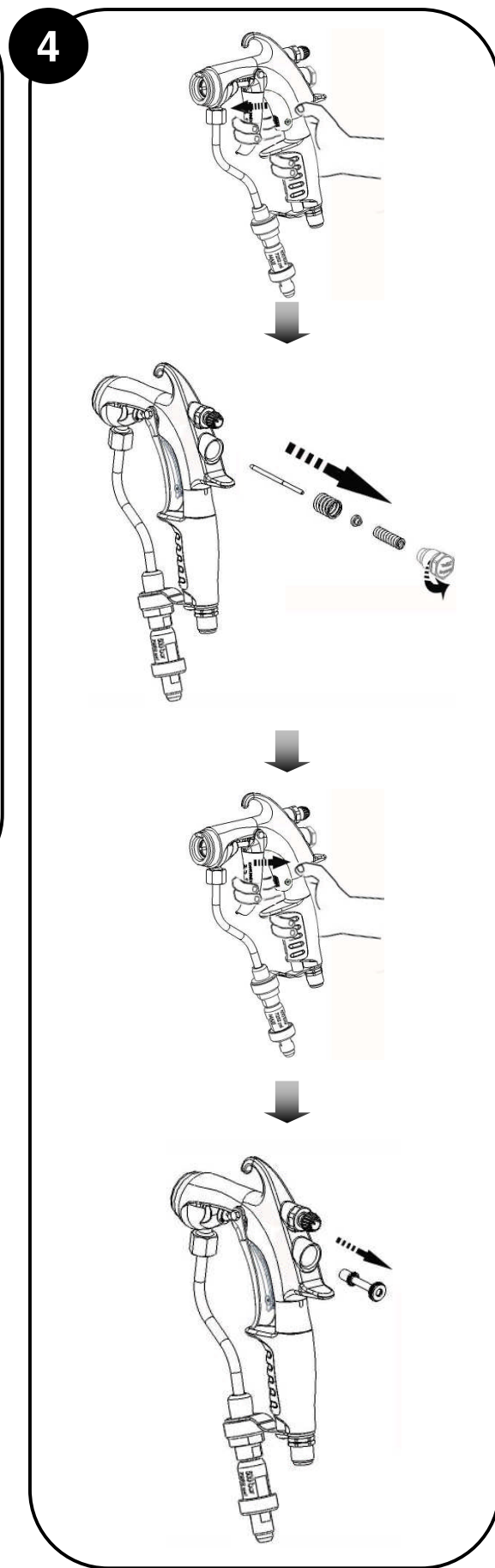
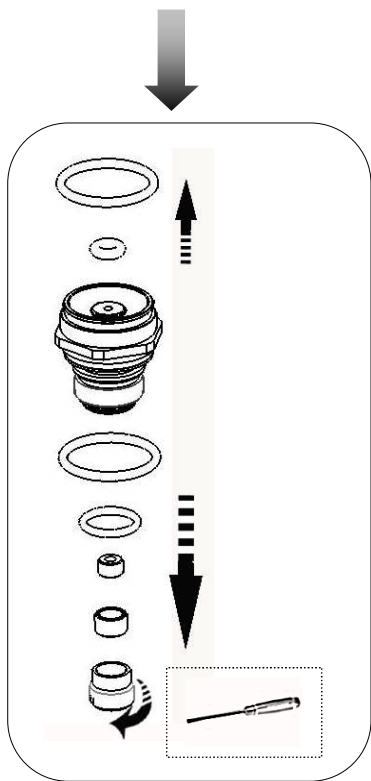
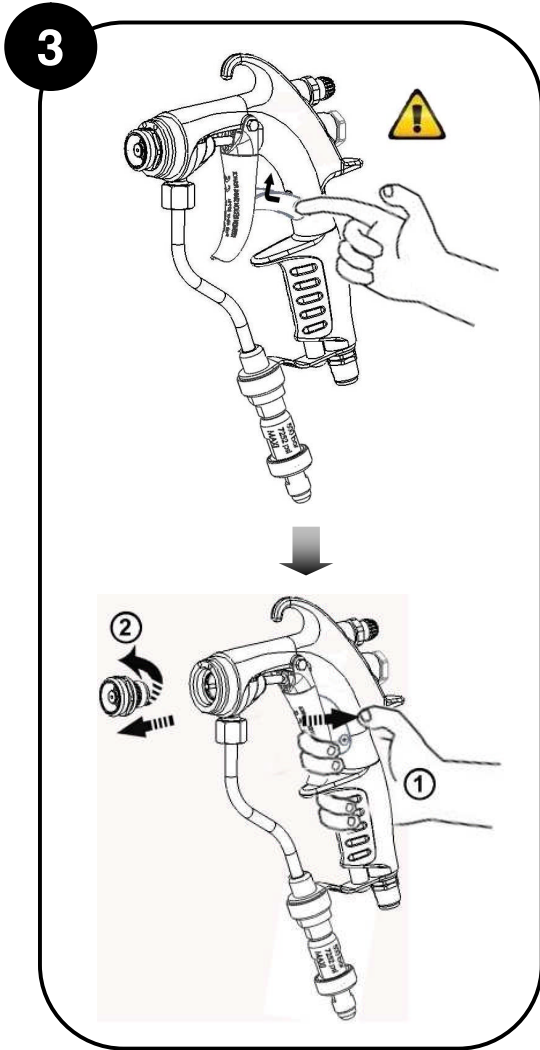

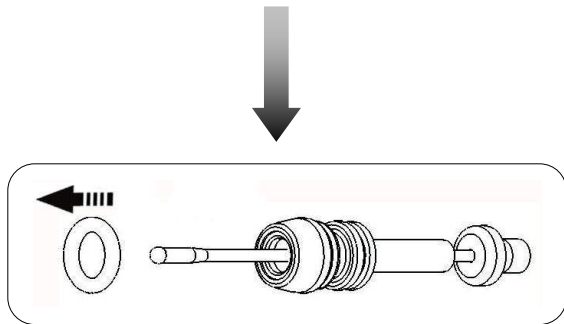
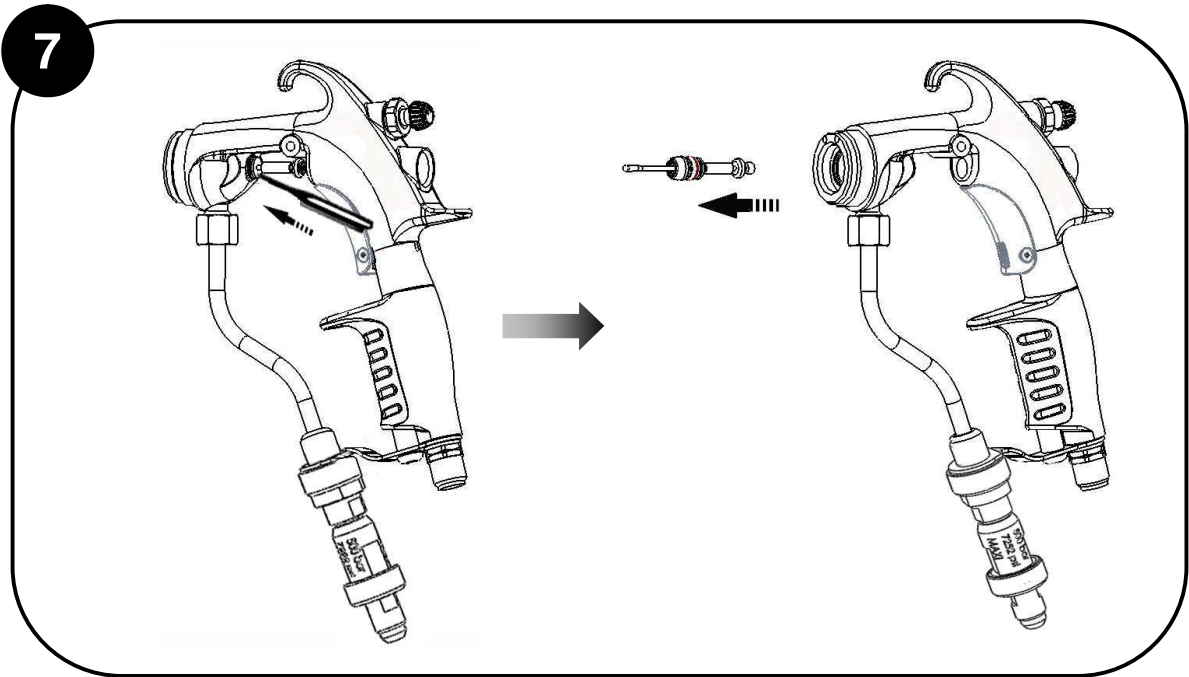
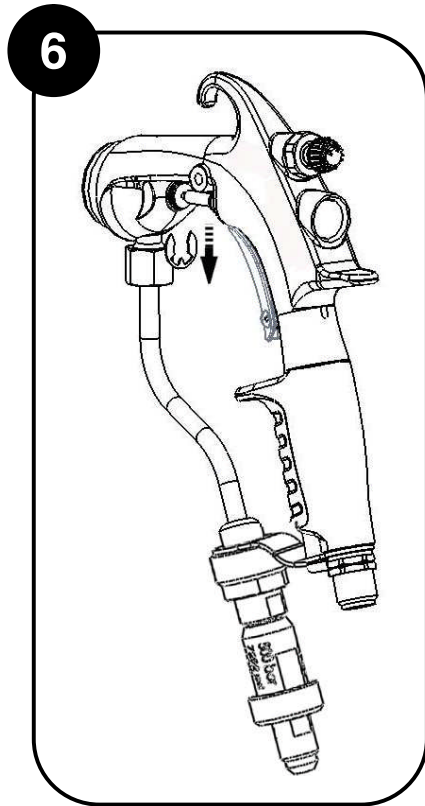
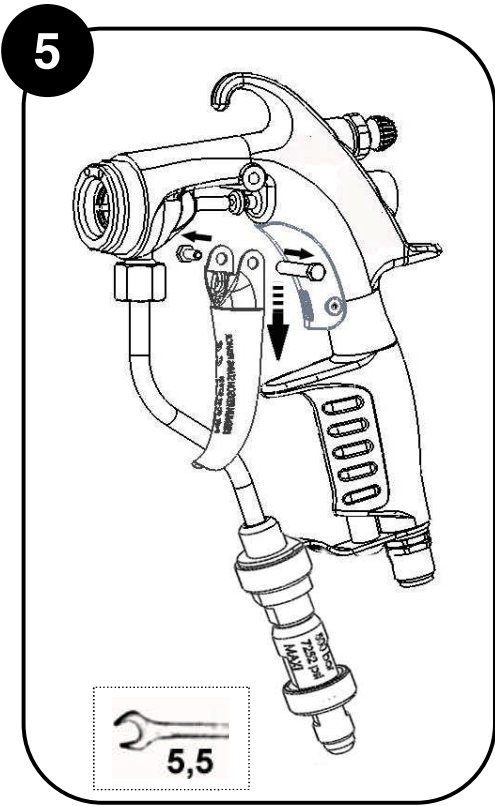

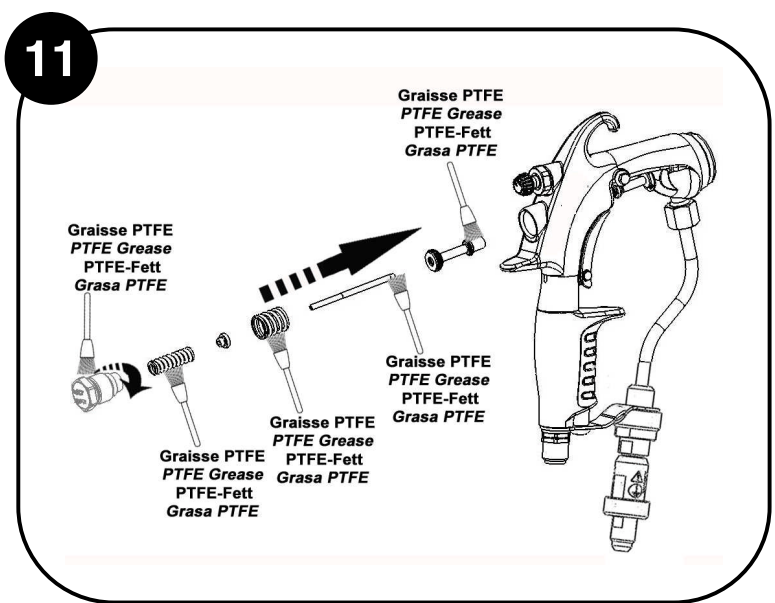
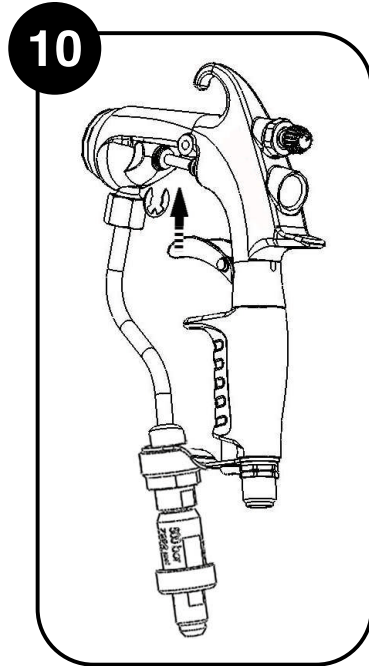
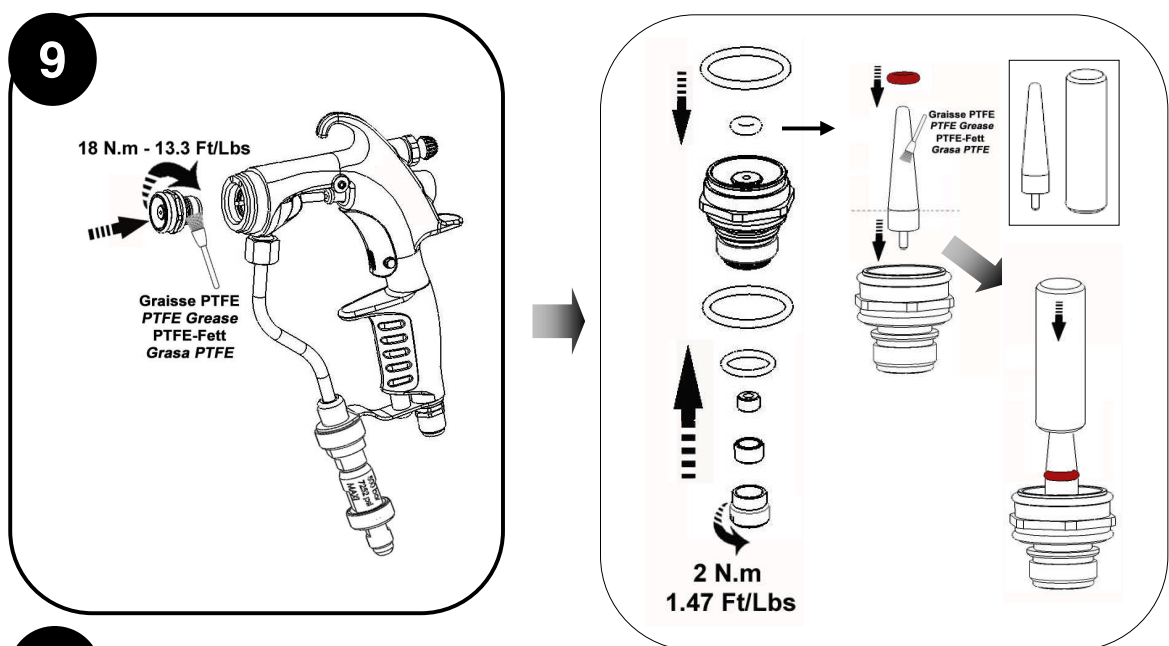
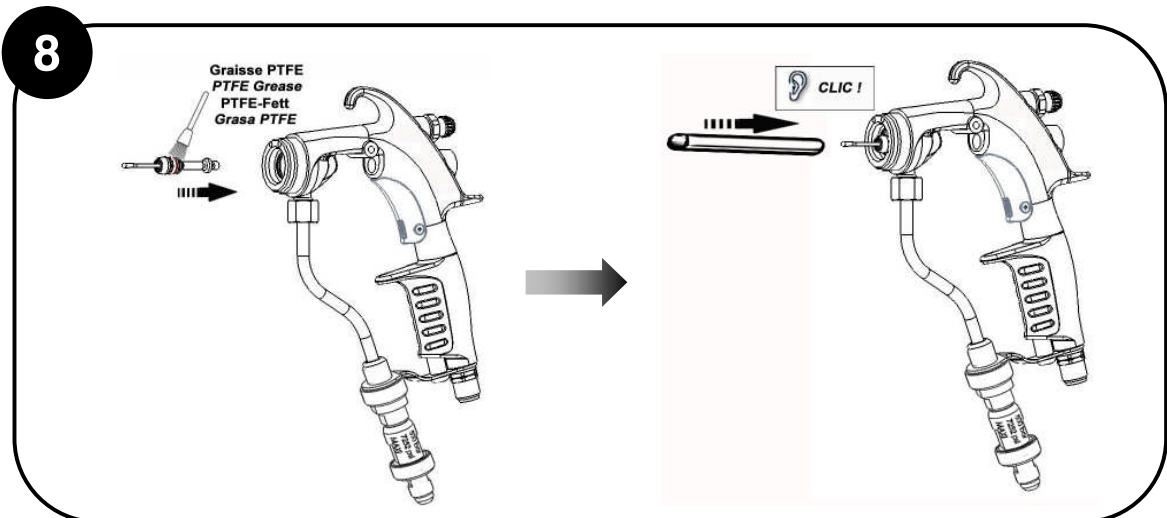

12

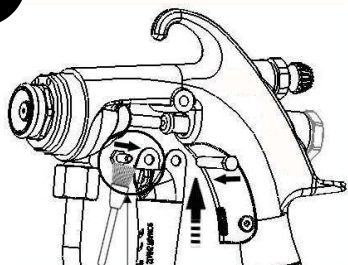

Colle Anaérobie frein filet faible
Low strength - Anaerobic Adhesive

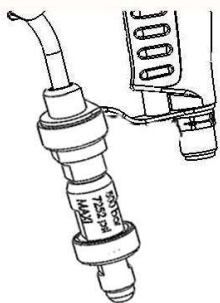

13

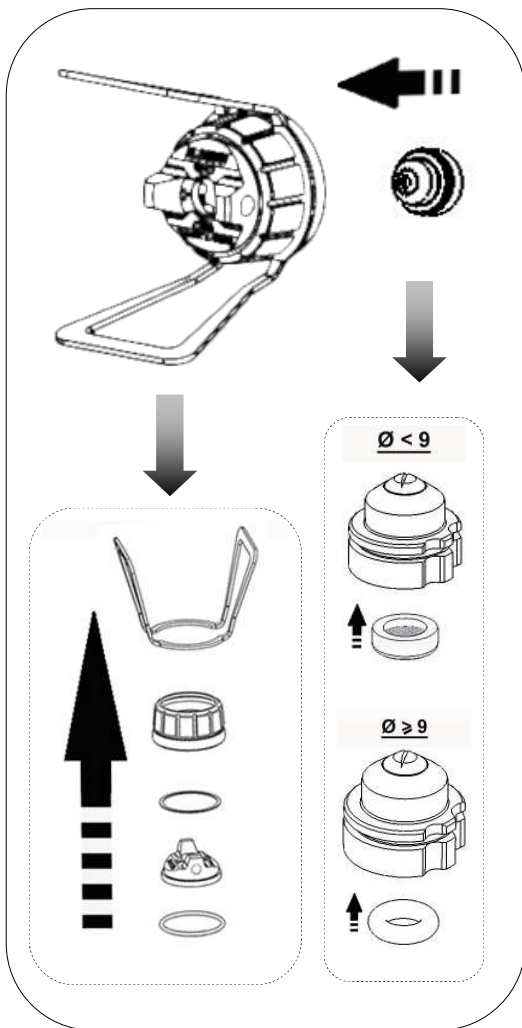
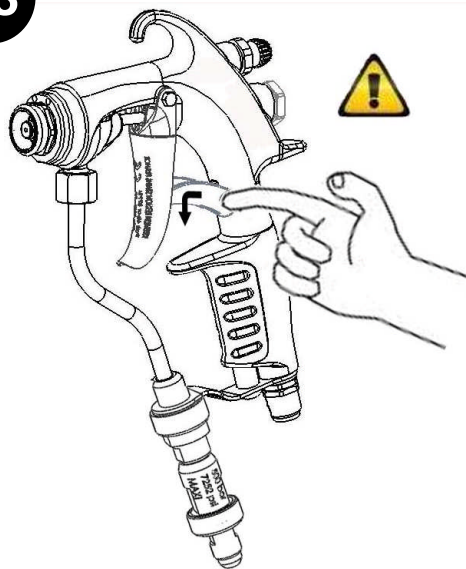

14

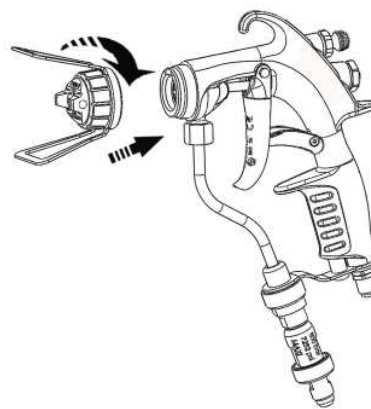

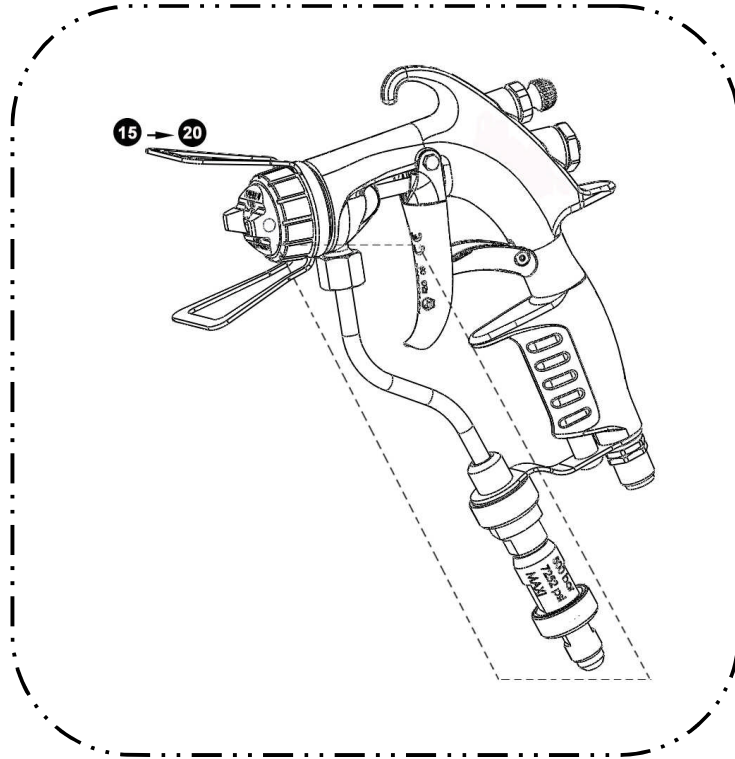

15

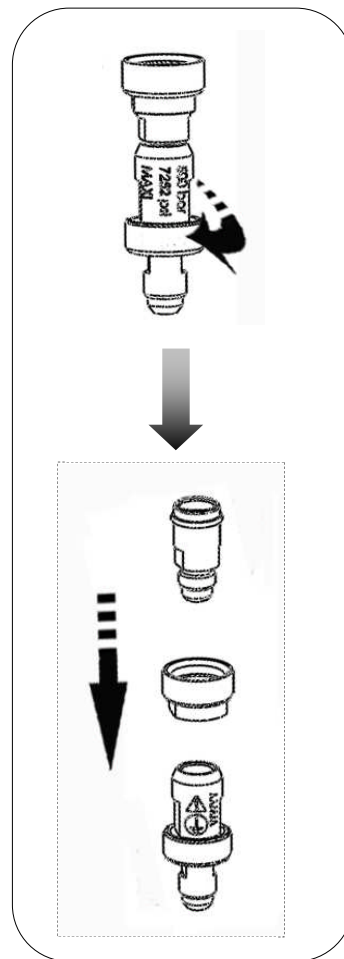
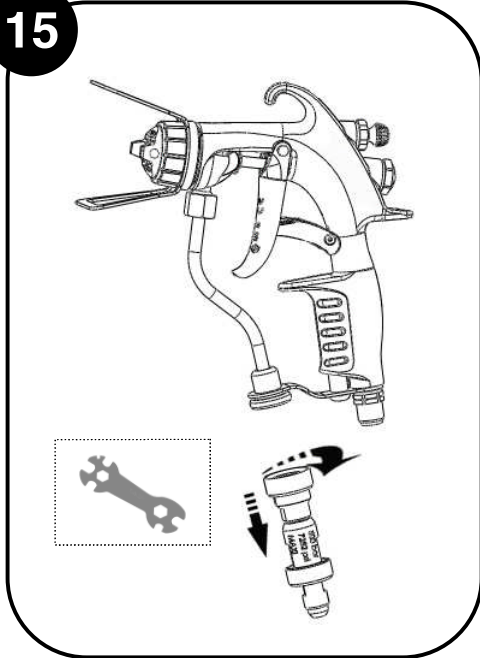

16

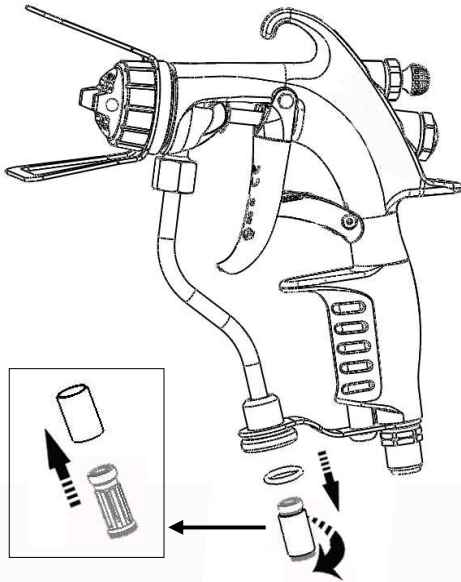

17

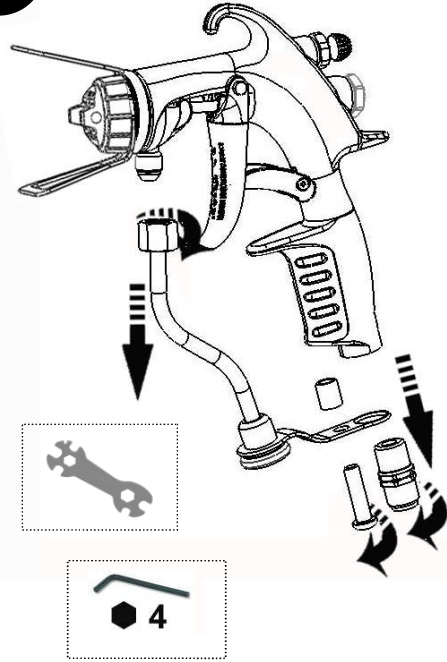

18

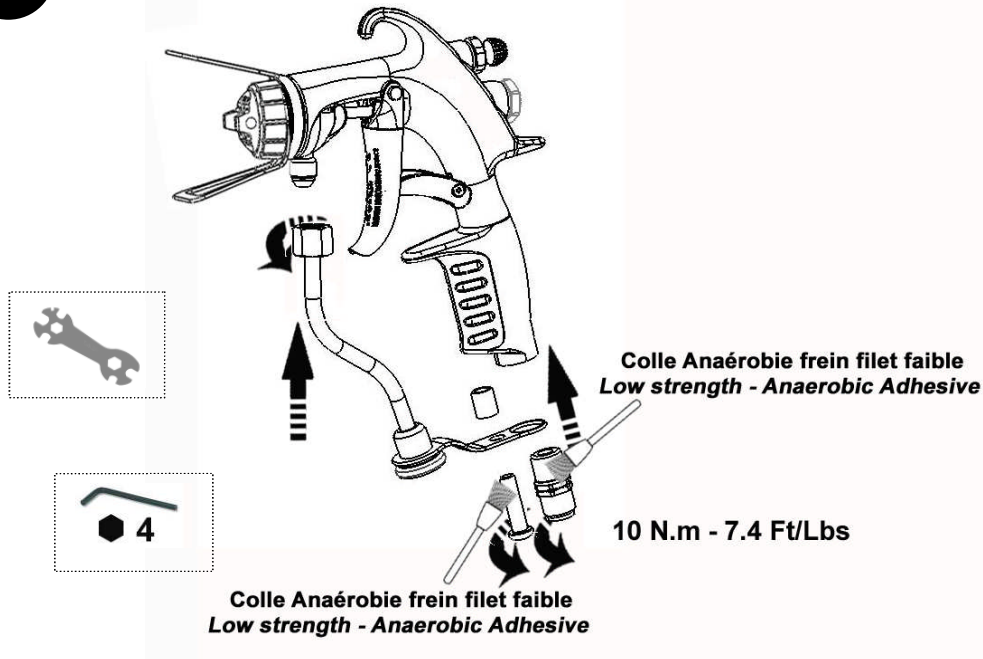

19

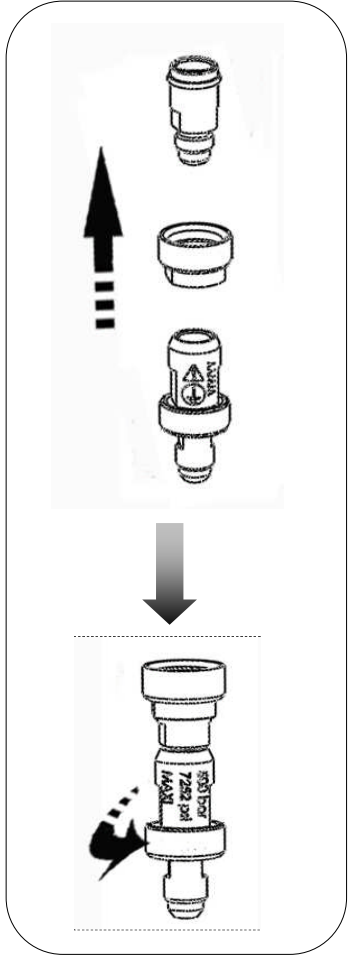
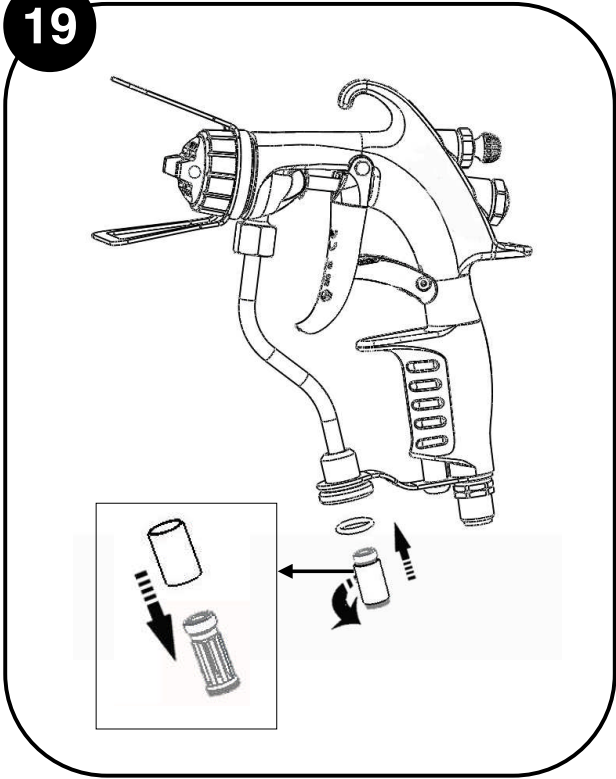

20

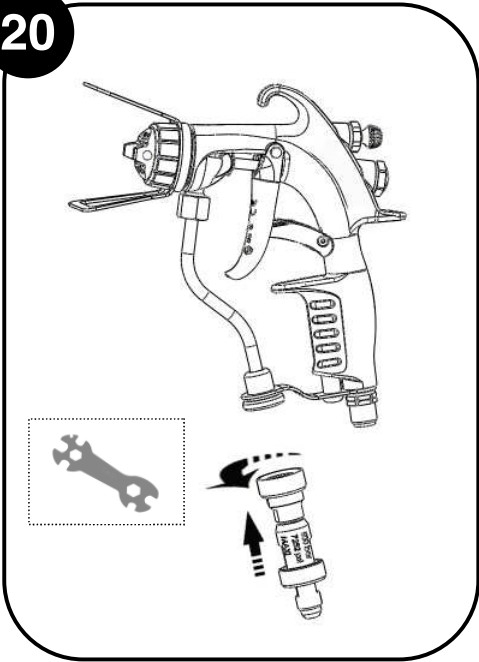

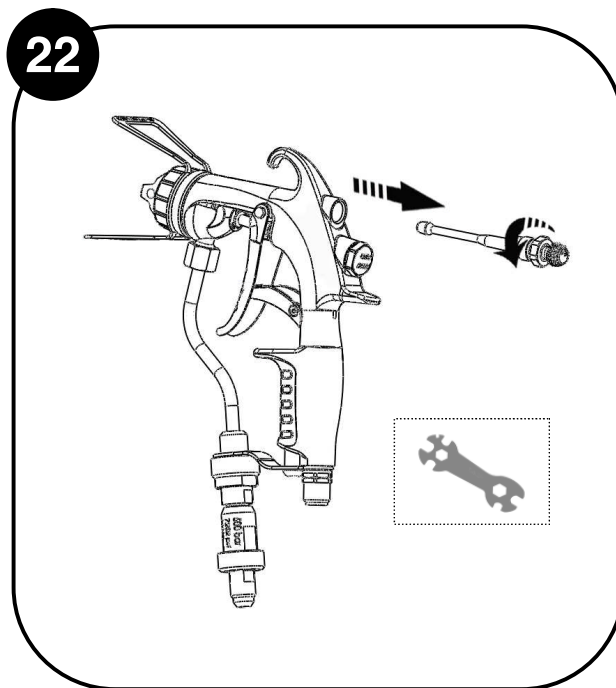
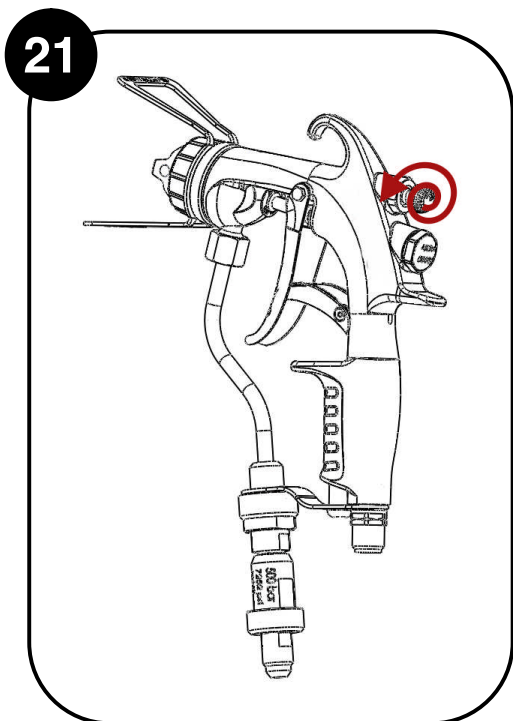
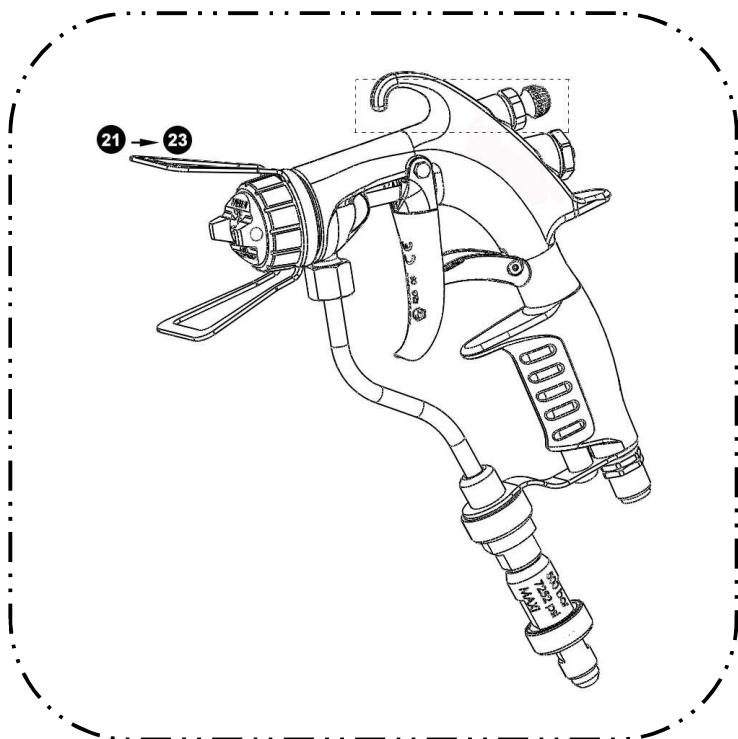

23

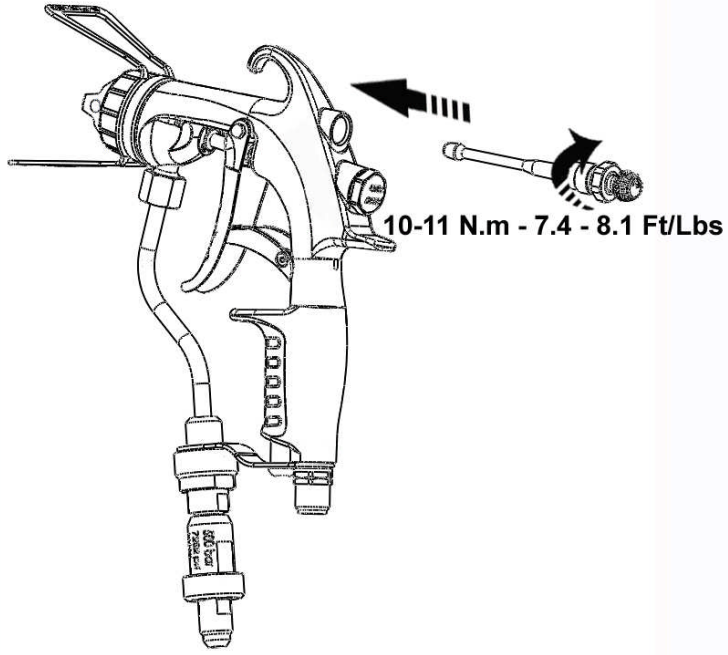

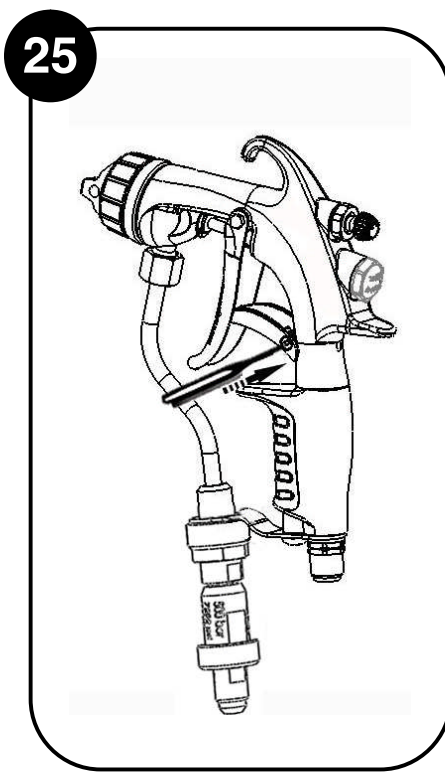
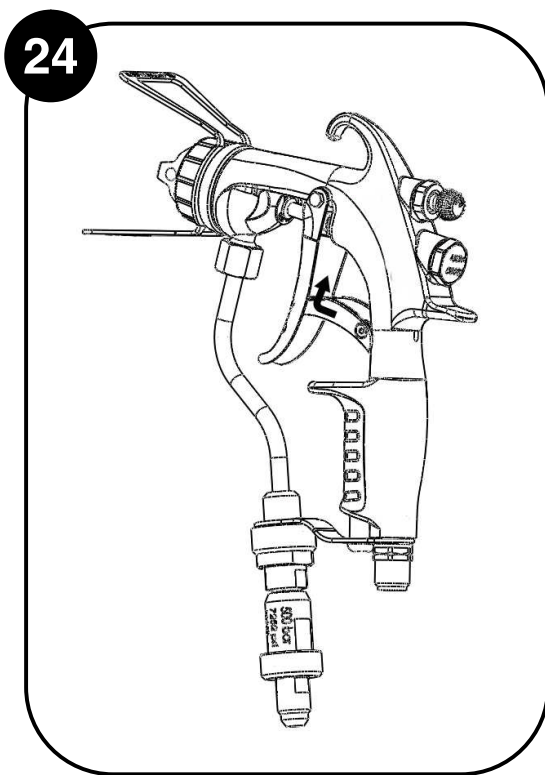
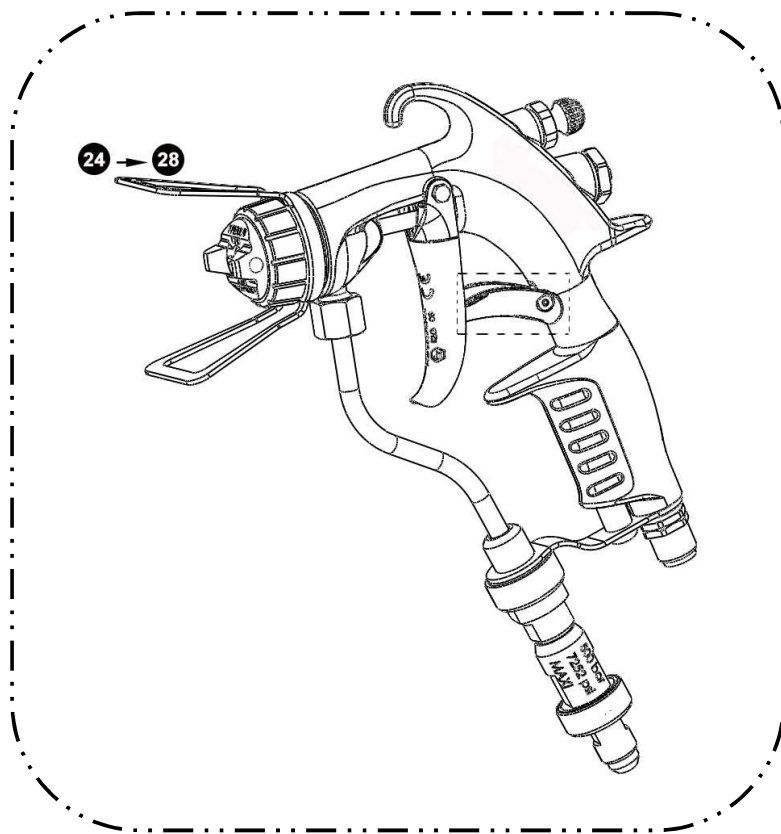

26

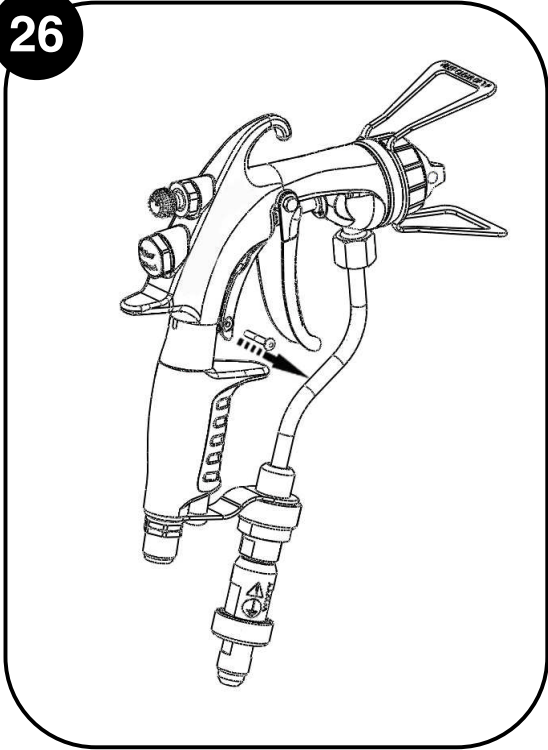

27

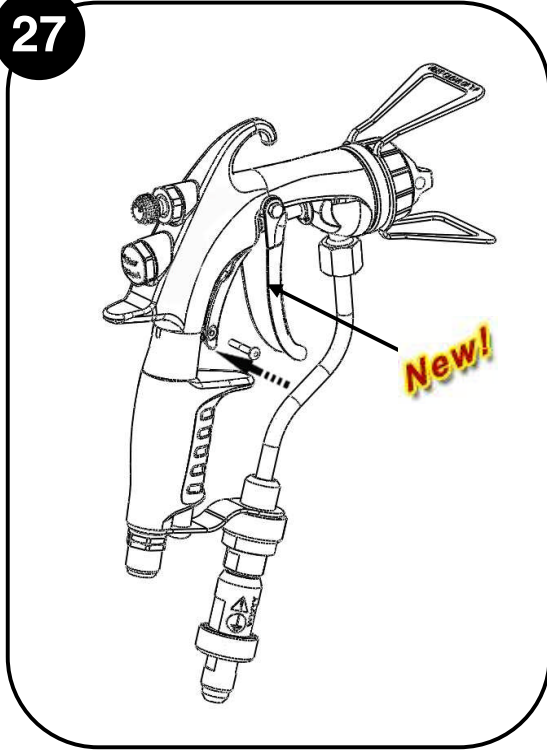

28

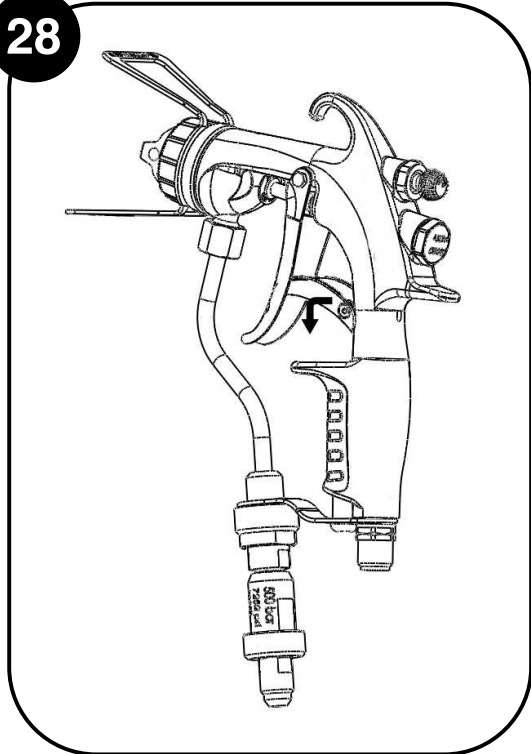

**PIECES DE RECHANGE
SPARE PARTS
ERSATZTEILLISTE
PIEZAS DE REPUESTO**

XCITE™

NOTICE ORIGINALE
/ TRANSLATION FROM THE ORIGINAL MANUAL
/ ÜBERSETZUNG DER ORIGINAL BETRIEBSANLEITUNG
/ TRADUCCIÓN DEL LIBRO ORIGINAL

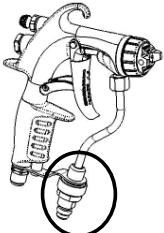
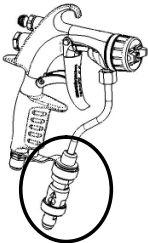
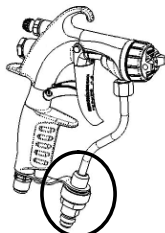
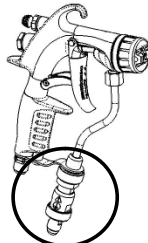
<p>120 bar / 1740 psi # 135.720.120</p>  <p><u>Avec filtre en ligne</u> <u>With inline filter</u> <u>Mit inline filter</u> <u>Con filtro en línea</u></p>	<p>120 bar / 1740 psi # 135.720.100</p>  <p><u>Avec raccord tournant</u> <u>With swivel fitting</u> <u>Mit Drehgelenk</u> <u>Con racor giratorio</u></p>	<p>200 bar / 2900 psi # 135.720.220</p>  <p><u>Avec filtre en ligne</u> <u>With inline filter</u> <u>Mit inline filter</u> <u>Con filtro en línea</u></p>	<p>200 bar / 2900 psi # 135.720.200</p>  <p><u>Avec raccord tournant</u> <u>With swivel fitting</u> <u>Mit Drehgelenk</u> <u>Con racor giratorio</u></p>	<p>↔ 2 - 4</p>
---	--	---	--	----------------

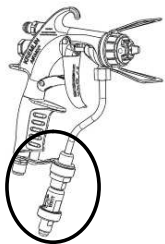
<p>400 bar / 5800 psi # 135.720.400</p>  <p><u>Avec filtre en ligne & raccord tournant SFS</u> <u>With inline filter & SFS swivel fitting</u> <u>Mit inline filter & SFS-Drehgelenk</u> <u>Con filtro en línea & racor giratorio SFS</u></p>	<p>↔ 5 - 7</p>
---	----------------

<p><u>Tableau des buses / Tip chart / Düsentabelle / Cuadro de las boquillas</u></p> 	<p>↔ 8</p>
---	------------

120 bar / 1740 psi & 200 bar / 2900 psi

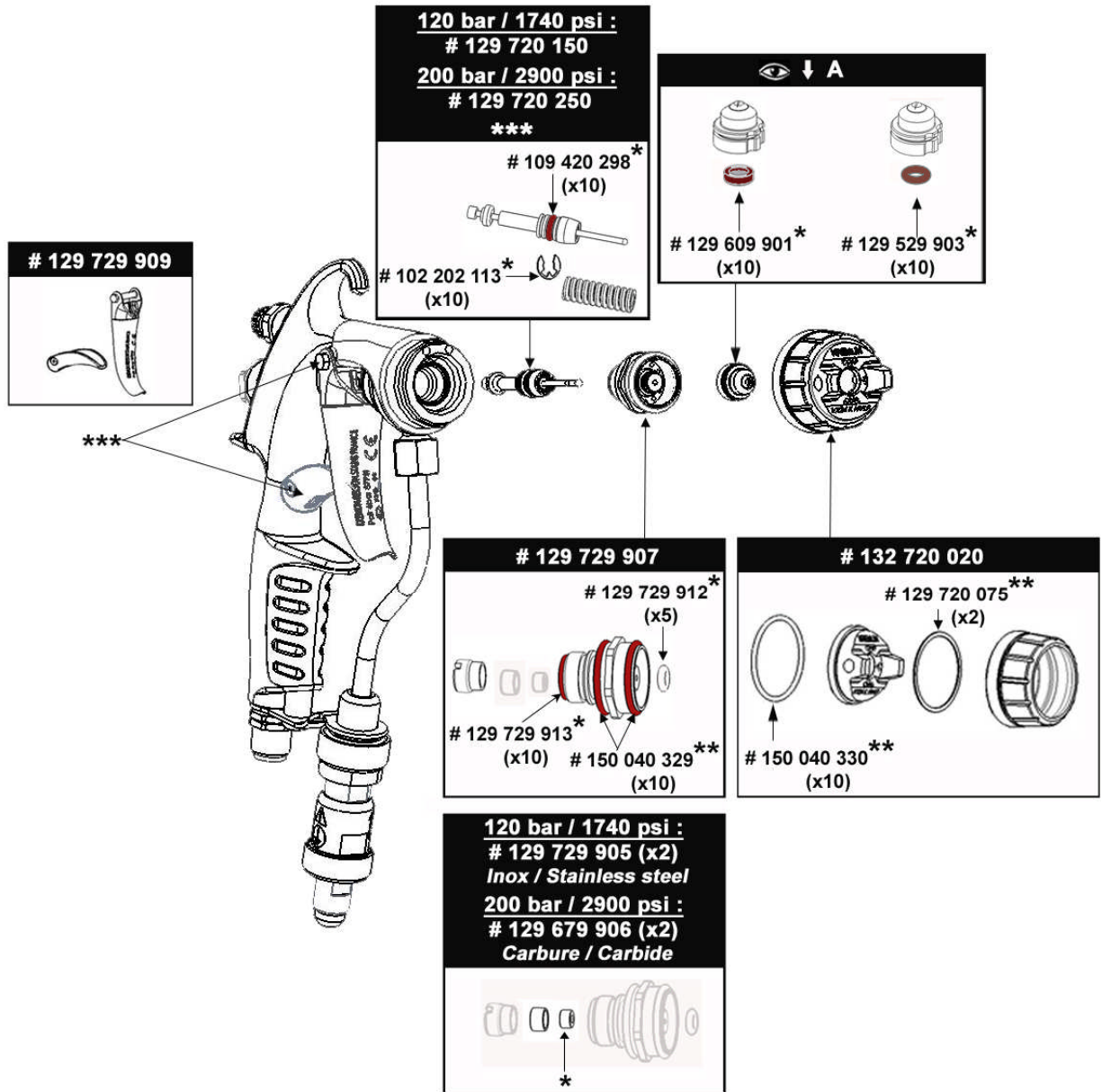

* Pochette de joints - produit / Paint seal kit
Dichtungssatz - Material / Bolsa de juntas - producto

** Pochette de joints - air / Air seal kit
Dichtungssatz - Luft / Bolsa de juntas - aire

*** Pochette maintenance / Servicing kit
Reparatursatz / Bolsa de reparación

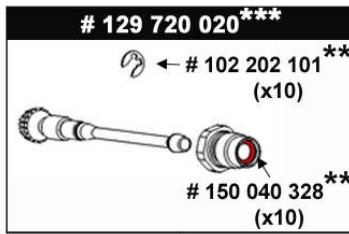

120 bar / 1740 psi : E
200 bar / 2900 psi : G



120 bar / 1740 psi : F
129 729 914 (x5)

200 bar / 2900 psi : H
129 729 915 (x5)
bleu / blue
blau / azul

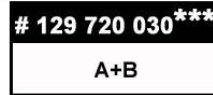

050 102 624

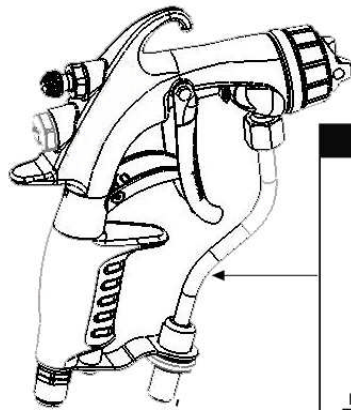

129 520 370

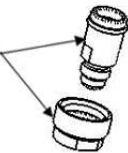

129 670 401

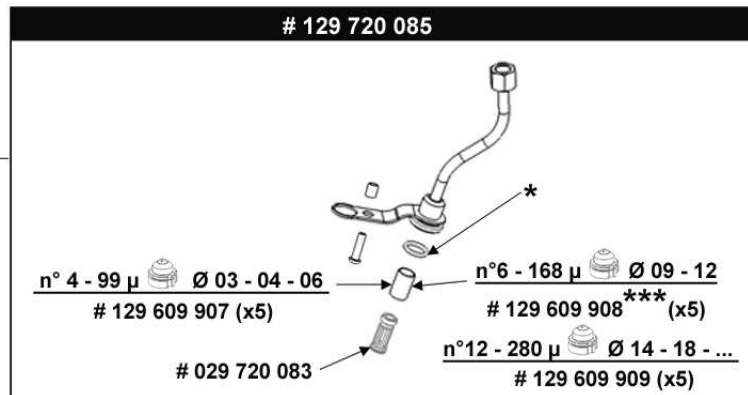
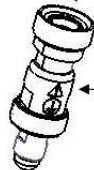

* Pochette de joints - produit / Paint seal kit
Dichtungssatz - Material / Bolsa de juntas - producto

** Pochette de joints - air / Air seal kit
Dichtungssatz - Luft / Bolsa de juntas - aire

*** Pochette maintenance / Servicing kit
Reparaturatz / Bolsa de reparación

OPTIONS / OPTIONAL / OPTIONEN / OPCIONES

120 bar / 1740 psi & 200 bar / 2900 psi

129 729 901
Produit / Paint

129 729 908
Air

120 bar / 1740 psi
129 729 920
200 bar / 2900 psi
129 729 921

Produit / Paint

Air

129 729 904 (x10)
Acétale / Polyacetal

075 810 010
Longueur / Length : 400 mm

PMS / MWP :
Max 120 bar / 1740 psi

120 bar / 1740 psi
151 260 988
200 bar / 2900 psi
151 260 989
Ø 4,8 mm - 7,5 mm

Air

Produit / Paint

049 030 042

906 300 101

129 729 922

Ø < 09 # 000 094 000
Ø ≥ 09 # 000 094 002

400 bar / 5800 psi

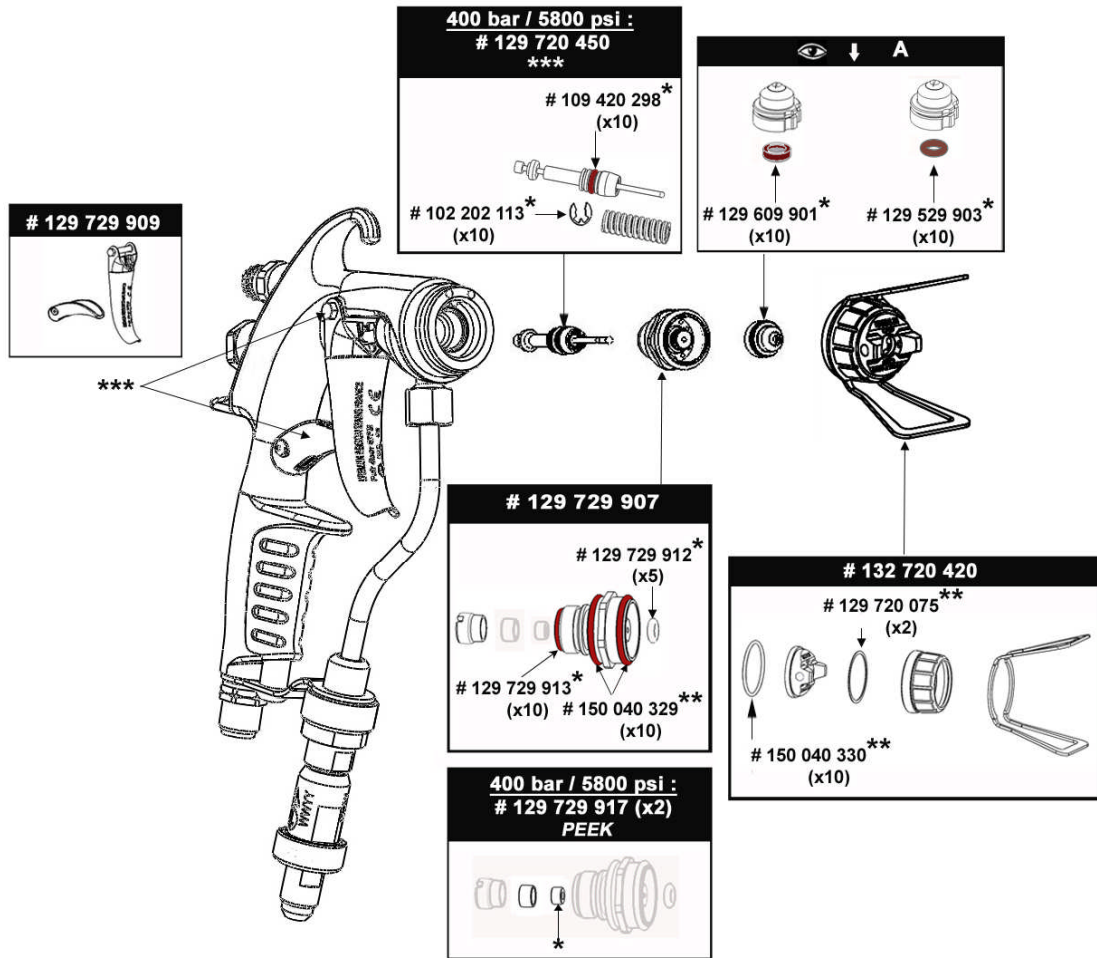

* Pochette de joints - produit / Paint seal kit
 Dichtungssatz - Material / Bolsa de juntas - producto

** Pochette de joints - air / Air seal kit
 Dichtungssatz - Luft / Bolsa de juntas - aire

*** Pochette maintenance / Servicing kit
 Reparatursatz / Bolsa de reparación

Kit 400 bar / 5800 psi
129 729 918
C+D+I+J

400 bar / 5800 psi : I

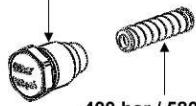

400 bar / 5800 psi : J
129 729 916 (x5)
rouge / red
rot / rojo

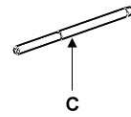
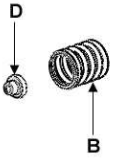

129 720 020***
 ← # 102 202 101**
 (x10)
 # 150 040 328**
 (x10)

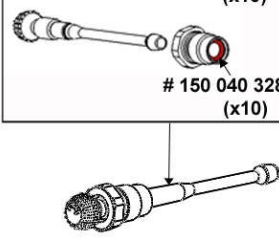

129 720 030***
A+B

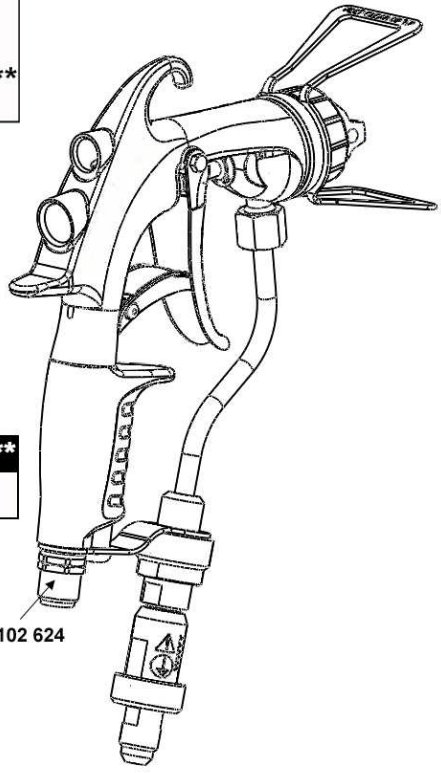

050 102 624

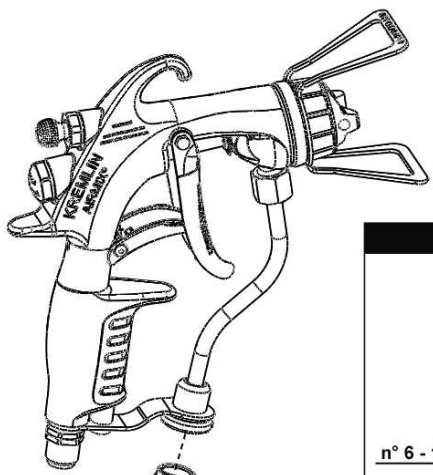

129 720 085

n° 6 - 168 μ	Ø 09 - 12	n° 4 - 99 μ	Ø 03 - 04 - 06
# 129 609 908***	(x5)	# 129 609 907	(x5)
# 029 720 083		n° 12 - 280 μ	Ø 14 - 18 - ...
		# 129 609 909	(x5)

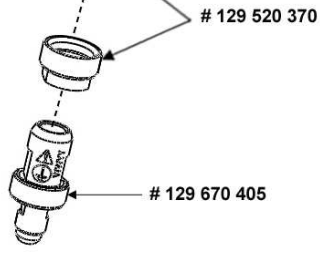

* Pochette de joints - produit / Paint seal kit
 Dichtungssatz - Material / Bolsa de juntas - producto
 ** Pochette de joints - air / Air seal kit
 Dichtungssatz - Luft / Bolsa de juntas - aire
 *** Pochette maintenance / Servicing kit
 Reparatursatz / Bolsa de reparación

OPTIONS / OPTIONAL / OPTIONEN / OPCIONES
400 bar / 5800 psi

129 729 941
Produit / Paint



129 729 908
Air



400 bar / 5800 psi
129 729 943



Produit / Paint

Air





049 030 042



906 300 101



 **Ø < 09 # 000 094 000**
 **Ø ≥ 09 # 000 094 002**

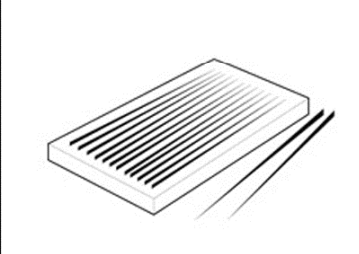

129 729 922



**ENTRETIEN PREVENTIF
PREVENTIVE
MAINTENANCE
VORBEUGENDE WARTUNG
MANTENIMIENTO
PREVENTIVO**

**PISTOLET AIRMIX® / AIRMIX® GUN
AIRMIX® HANDSPRITZPISTOLE / PISTOLA AIRMIX®**

NOTICE ORIGINALE
/ TRANSLATION OF THE ORIGINAL MANUAL
/ ÜBERSETZUNG DER ORIGINALBEDIENUNGSANLEITUNG
/ TRADUCCIÓN DEL LIBRO ORIGINAL

AVANT CHAQUE OPERATION DE MAINTENANCE
DO THIS BEFORE ANY MAINTENANCE ACTION
VOR JEDER WARTUNGSARBEIT IST FOLGENDES ZU TUN
ANTES DE CADA OPERACIÓN DE MANTENIMIENTO

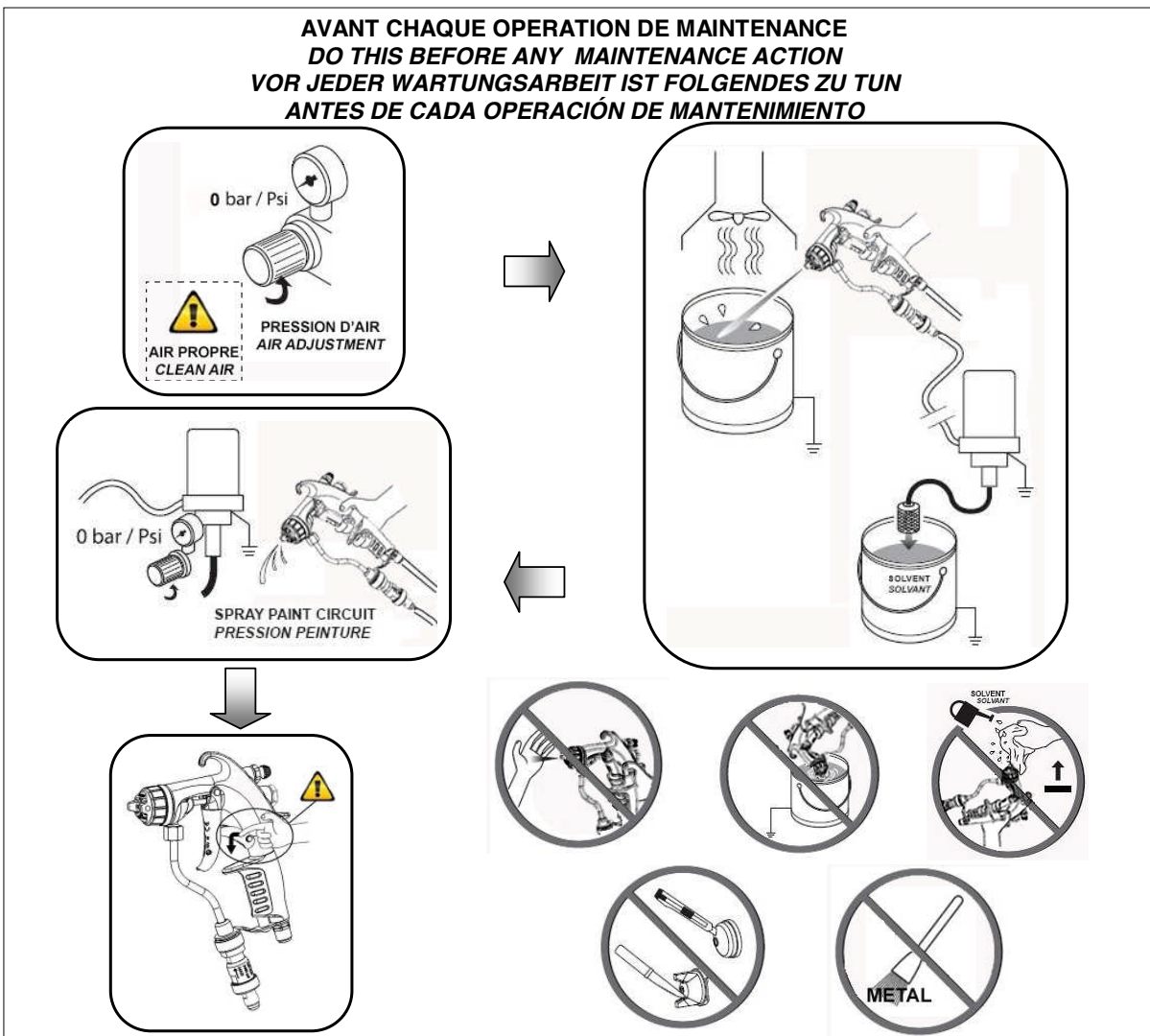

TOUS LES JOURS / DAILY TASKS / TÄGLICH / DIARIO

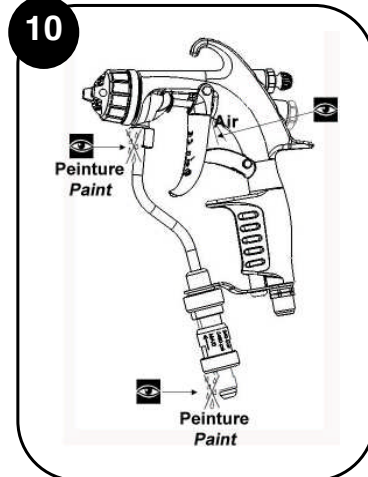
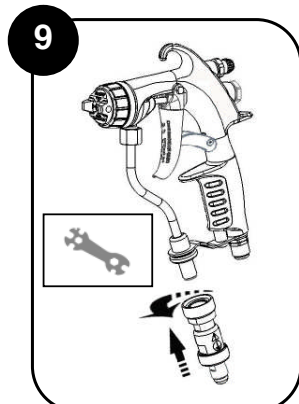
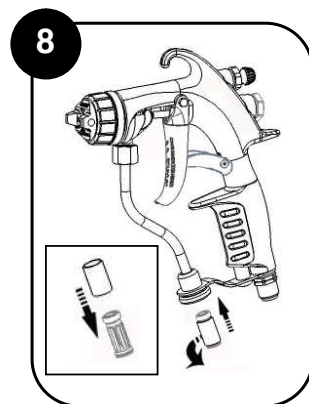
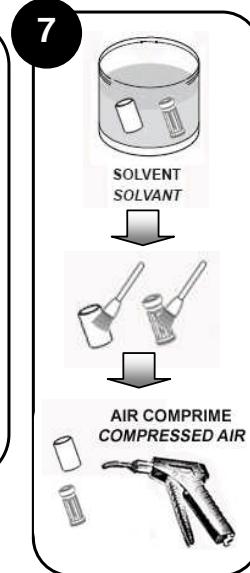
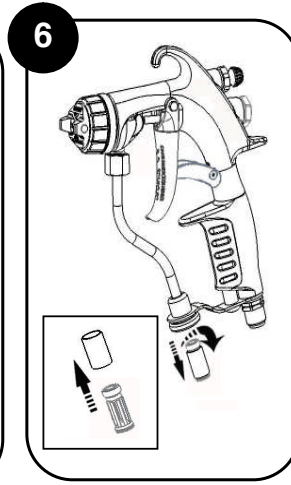
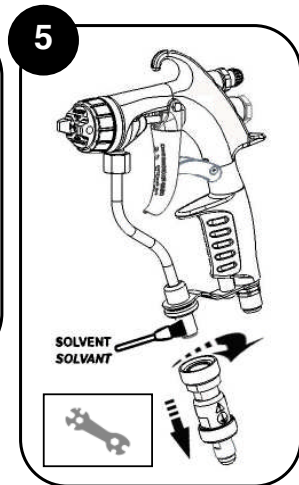
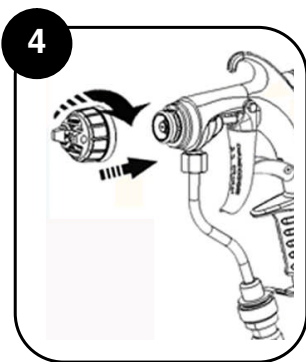
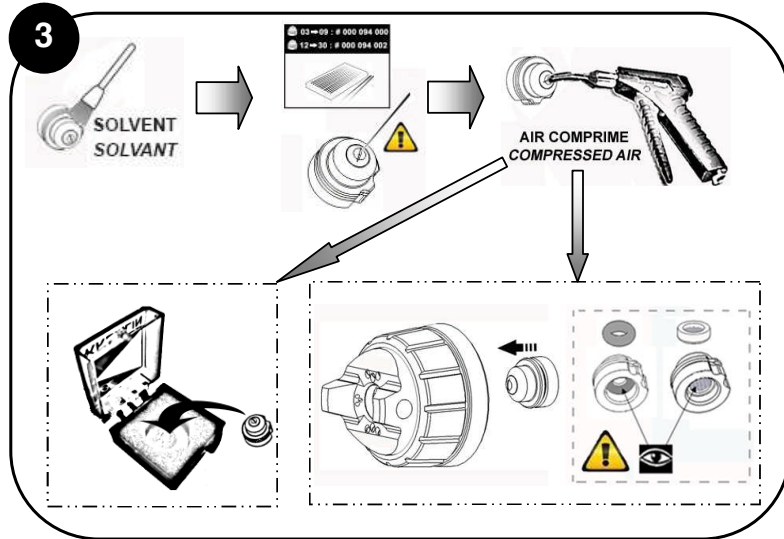
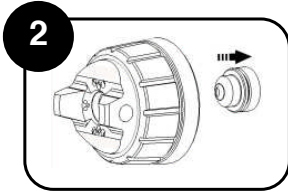
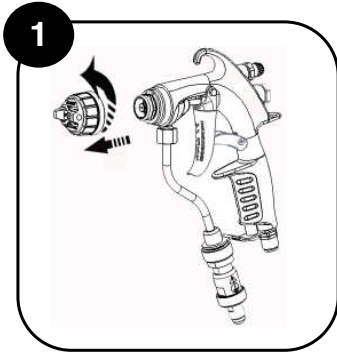

HEBDOMADAIRE / WEEKLY TASKS / WÖCHENTLICH / SEMANAL

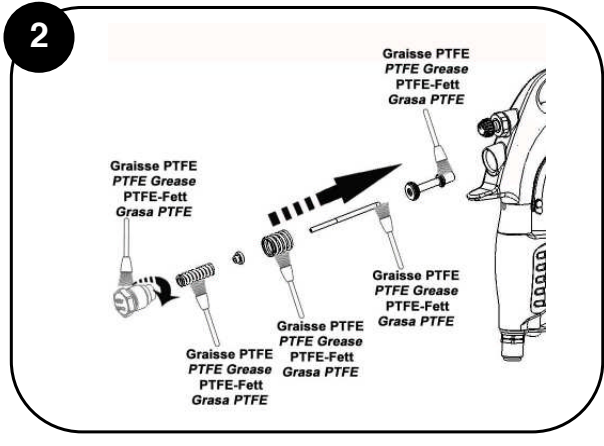
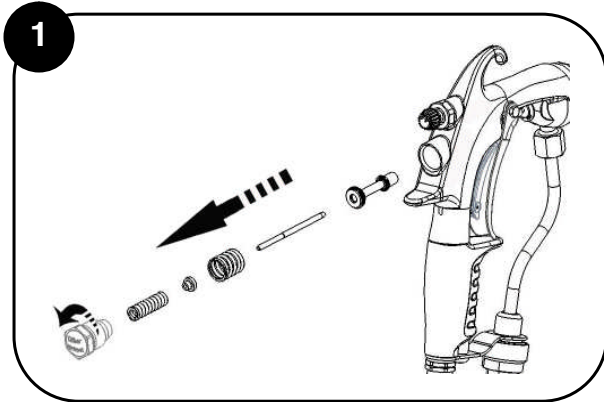
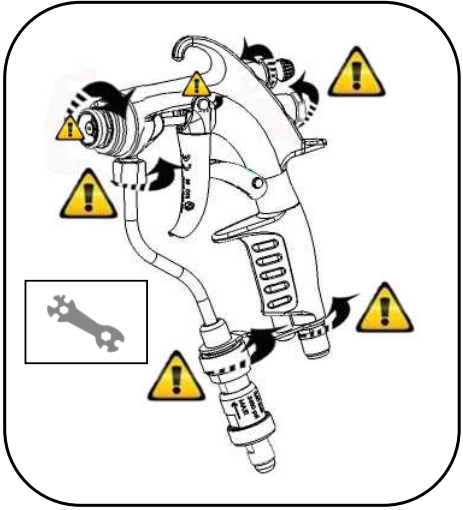

TRIMESTRIEL
/ QUARTERLY TASKS / VIERTELJÄHRLICH
/ TRIMESTRAL

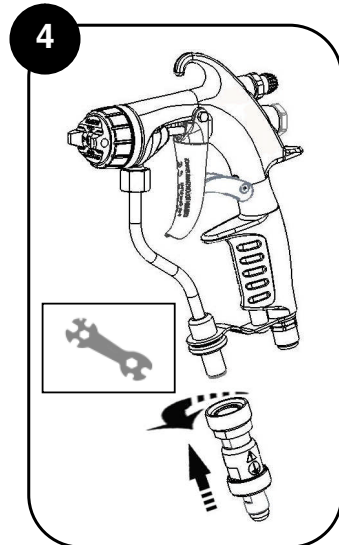
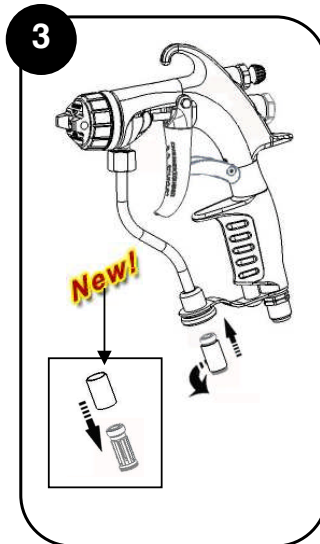
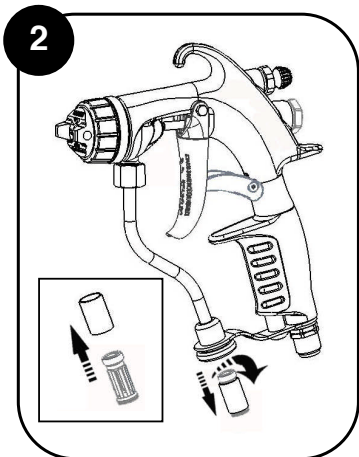
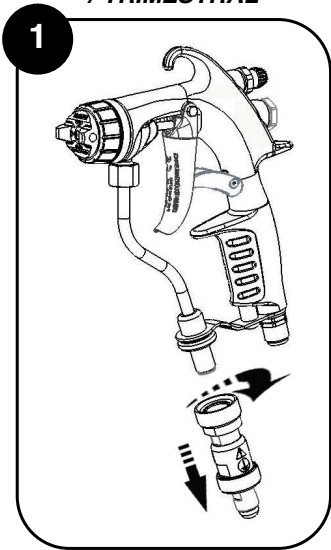

ANNUEL / YEARLY SERVICE / JÄHRLICH / ANUAL

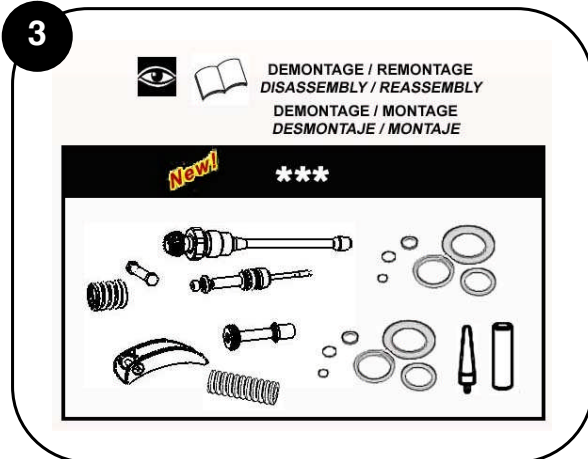
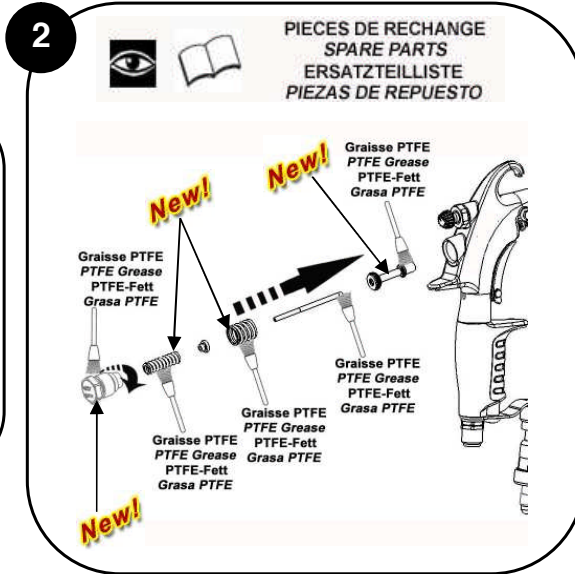
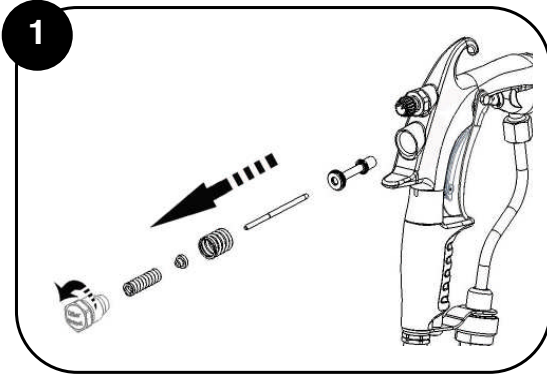

**GUIDE DE DEPANNAGE
TROUBLESHOOTING
FEHLERSUCHE
INCIDENCIAS DE
FUNCIONAMIENTO**

**PISTOLET AIRMIX® / AIRMIX® GUN
AIRMIX® HANDSPRITZPISTOLE / PISTOLA AIRMIX®**

NOTICE ORIGINALE
/ TRANSLATION OF THE ORIGINAL MANUAL
/ ÜBERSETZUNG DER ORIGINALBEDIENUNGSANLEITUNG
/ TRADUCCIÓN DEL LIBRO ORIGINAL

AVANT CHAQUE OPERATION DE MAINTENANCE
DO THIS BEFORE ANY MAINTENANCE ACTION
VOR JEDER WARTUNGSARBEIT IST FOLGENDES ZU TUN
ANTES DE CADA OPERACIÓN DE MANTENIMIENTO

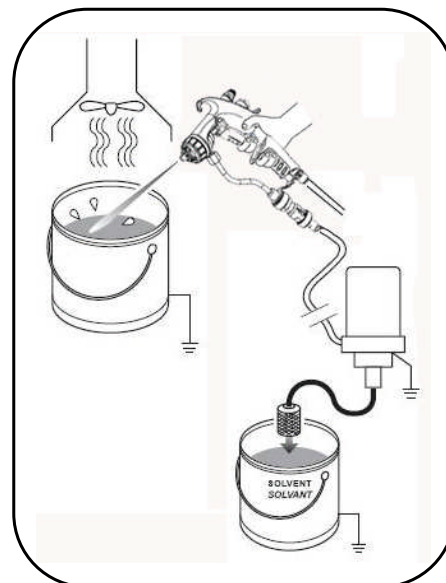
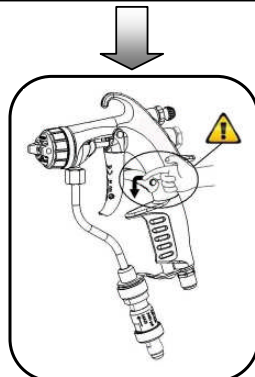
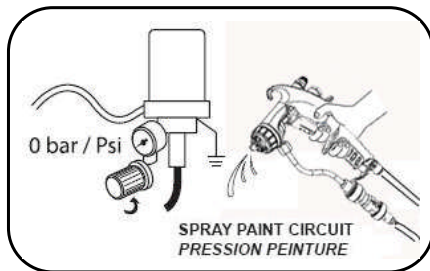

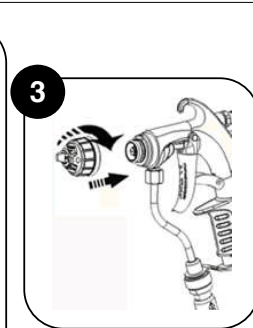
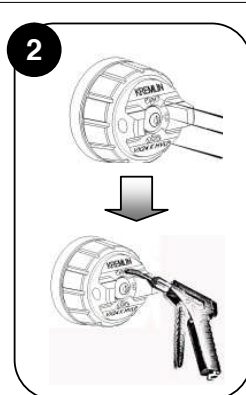
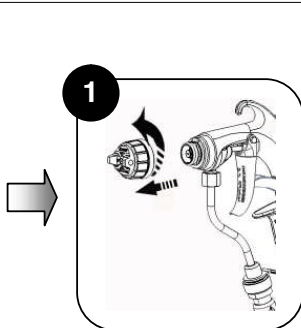
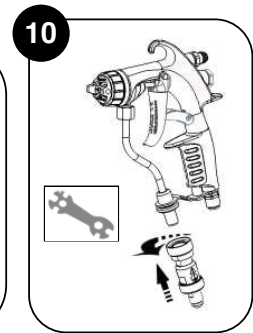
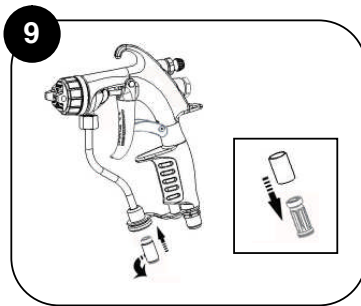
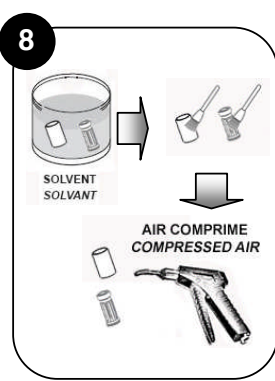
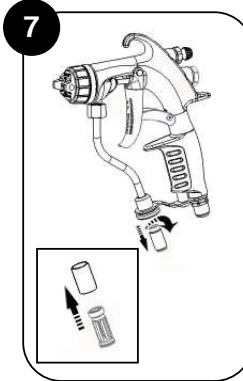
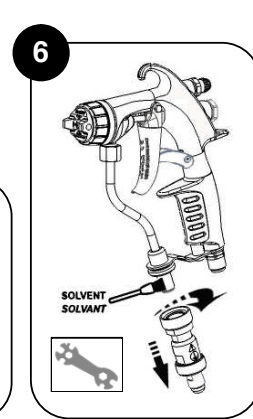
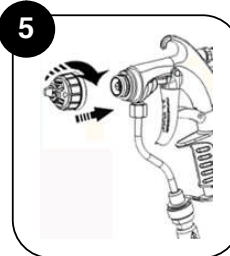
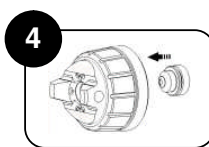
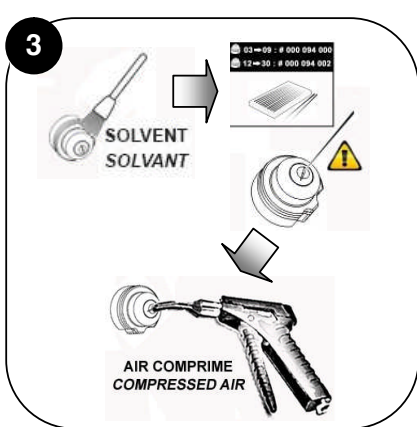
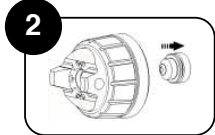
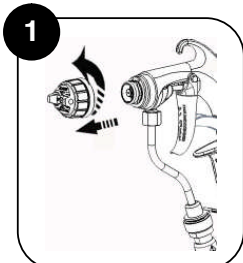
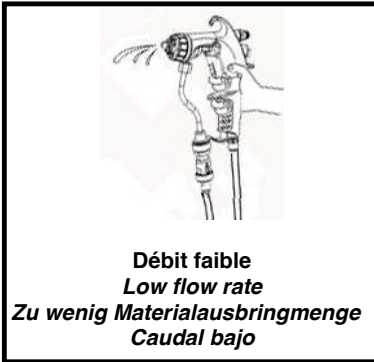

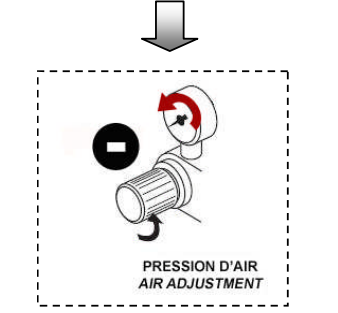
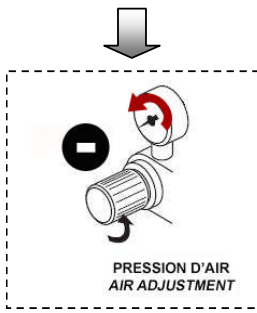
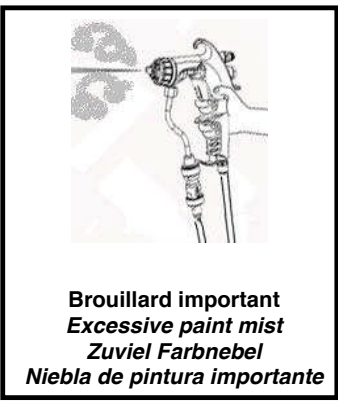
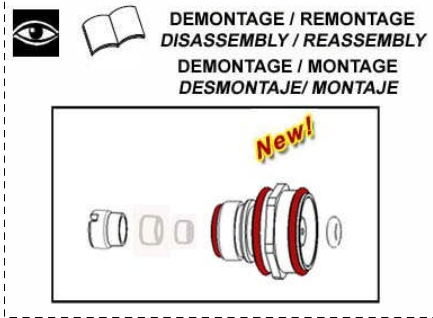
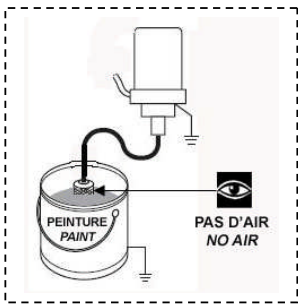
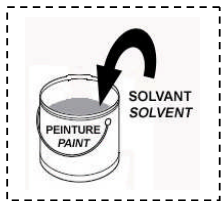
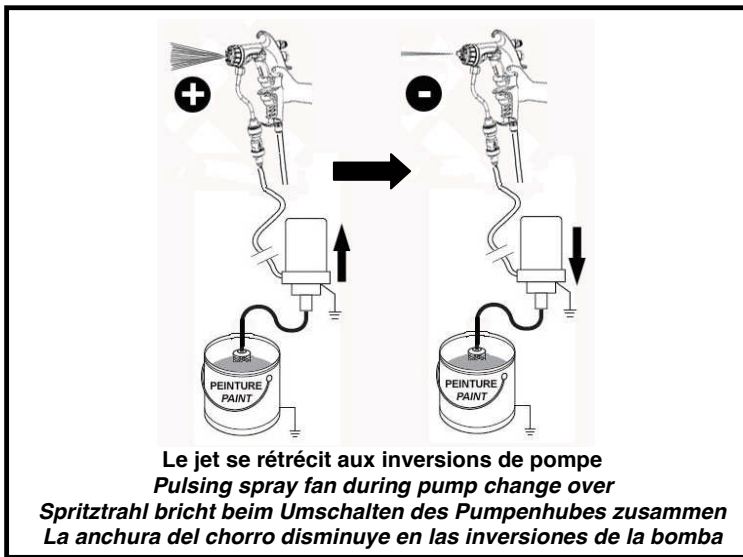

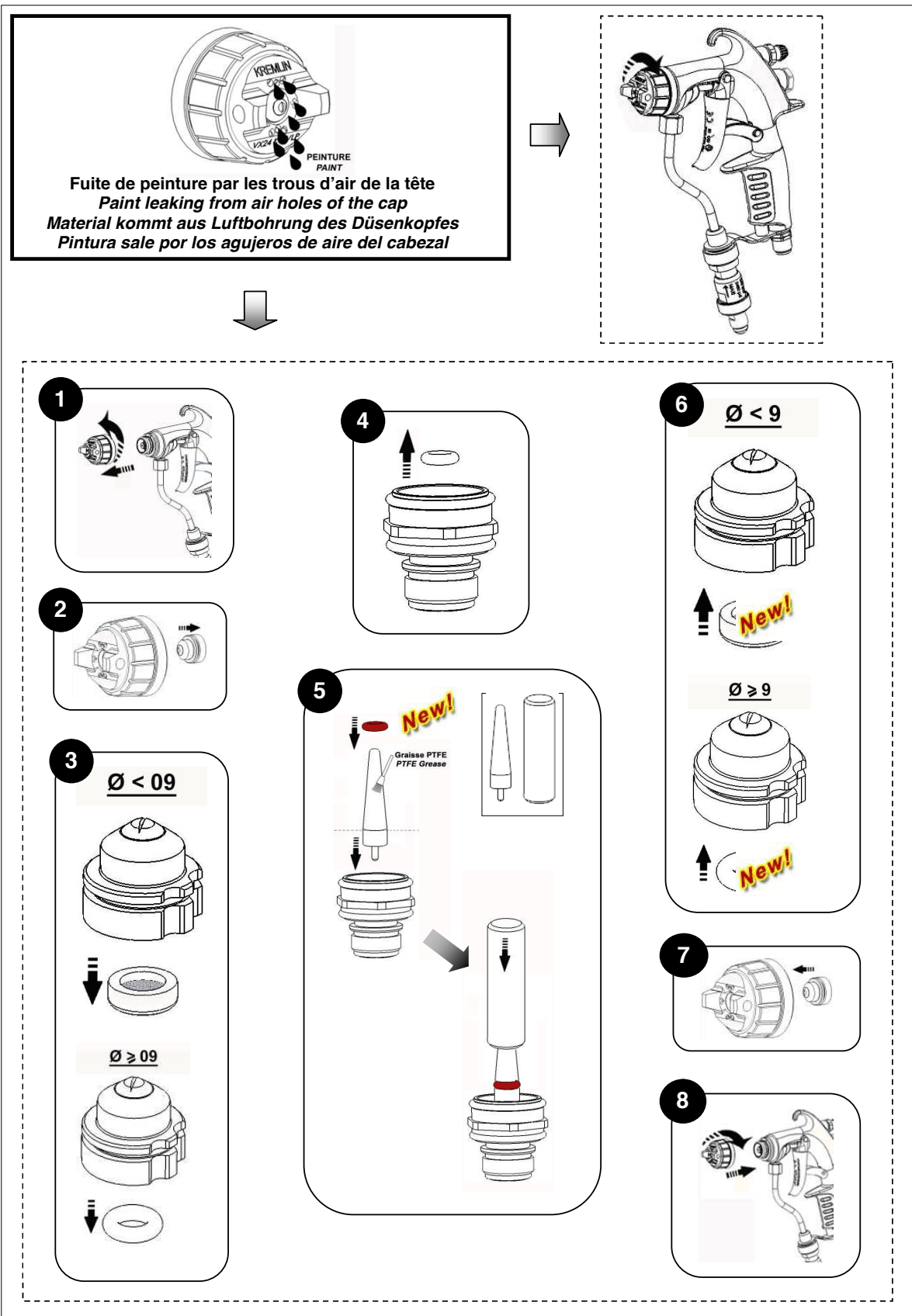

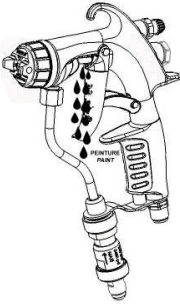

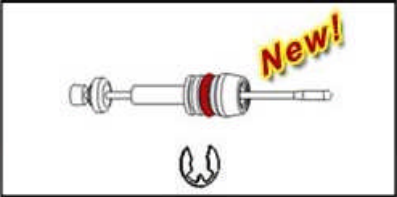

Fuite de peinture devant la gâchette
Paint leaks in front of the trigger
Materialaustritt an der Farbnadel beim Abzugshebel
Fuga de pintura delante del gatillo

DEMONTAGE / REMONTAGE
 DISASSEMBLY / REASSEMBLY
 DEMONTAGE / MONTAGE
 DESMONTAJE / MONTAJE





Goutelettes de peinture continues en sortie de buse
Paint leaks continuously from the spray tip
Andauernde Materialtröpfchen am Düsenkopf
Gotas de pintura salen de la boquilla en continuo

DEMONTAGE / REMONTAGE
 DISASSEMBLY / REASSEMBLY
 DEMONTAGE / MONTAGE
 DESMONTAJE / MONTAJE

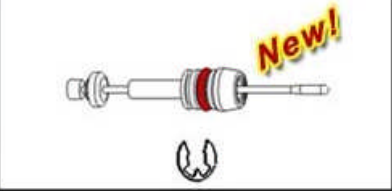
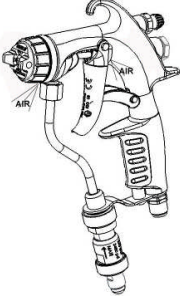

DEMONTAGE / REMONTAGE
 DISASSEMBLY / REASSEMBLY
 DEMONTAGE / MONTAGE
 DESMONTAJE / MONTAJE

Fuite d'air à l'avant du pistolet et/ou à l'arrière de la gâchette
Air leaking from air cap or / and behind the trigger
Beständiger Luftaustritt am Düsenkopf
Fuga de aire por la parte delantera de la pistola y / o por la parte trasera del gatillo

DEMONTAGE / REMONTAGE
 DISASSEMBLY / REASSEMBLY
 DEMONTAGE / MONTAGE
 DESMONTAJE / MONTAJE





AIRMIX®

MANUAL SPRAY GUN

START-UP AND HANDLING

TRANSLATION OF THE ORIGINAL MANUAL

IMPORTANT : before assembly and start-up, Please read and clearly understand all documents relating to this equipment (professional use only).

PICTURES AND DRAWINGS ARE NON CONTRACTUAL. WE RESERVE THE RIGHT TO MAKE CHANGES WITHOUT PRIOR NOTICE.

KREMLIN - REXSON

150, avenue de Stalingrad
93 245 - STAINS CEDEX – France

☎ : 33 (0)1 49 40 25 25 Fax : 33 (0)1 48 26 07 16

www.kremlin-rexson.com

START-UP



Safety instructions :

- Never try to stop the spray fan with any part of the body (hands, fingers...) or with rags. Never point the spray gun at anyone or at any part of the body.
- The operator will need medical attention if the high pressure material spray is in contact with the the body (eyes, fingers...).
- **Always lock the gun trigger with the safety device when not operating the gun.**
- **Always depressurize air and hoses** before carrying out any servicing on the gun.



In order to protect the operator, protective clothing (gloves, hearing protective earplug, respirator mask, glasses, clothes...) are required.
Use the equipment in a properly ventilated area.

- 1 - Prepare the paint (blend and filter the paint to the appropriate viscosity - refer to the material technical data).
- 2 - The air supply to the equipment must be (clean dry air, maximum air pressure = 6 bar / 87 psi)
- 3 - Prime the pump (refer to pump instruction manual).
- 4 - Unlock the safety device to release the gun trigger. Point the gun into a waste container and and open the gun by using the trigger until clean material flows.
- 5 - Lock the safety device.
- 6 - Select a spray nozzle (refer to AIRMIX ®.nozzle chart).
- 7 - Make sure white seal or micro-filter is in place in the spray nozzle.
- 8 - Install the spray nozzle inside the air cap being certain the locating pins are aligned with mating recesses of the nozzle.
- 9 - Insert the air cap with its nozzle into the retaining ring. Screw retaining ring and air cap firmly onto the spray gun positioning the air cap to obtain the desired pattern orientation.
- 10 - Unlock the safety device and trigger the gun.
- 11 - Adjust the pump air pressure (red regulator) for the desired flow rate.
NB: Increase fluid pressure until the spray fan is correct. Stop adjustment when the spray fan is giving the best results.
- 12 - Adjust spraying air pressure (grey regulator) until the pattern is even.
NB: The drawing shows the relation between fan pattern and spraying air pressure.

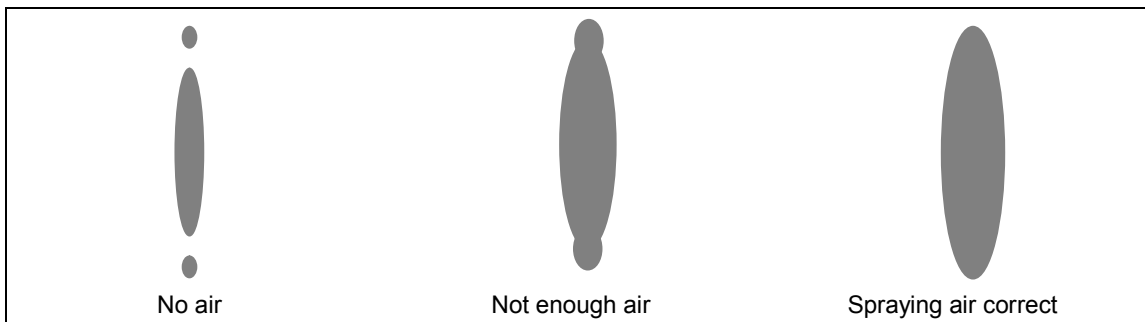

➤ **To optimize Airmix® spraying , do not increase spraying air pressure once the correct fan is obtained. It would lead to more spraying mist.**

- 13 - Optimize fan width by means of the air adjusting knob located at the rear part of the gun.
Air knob closed → large fan
Air knob open → narrow fan → round fan

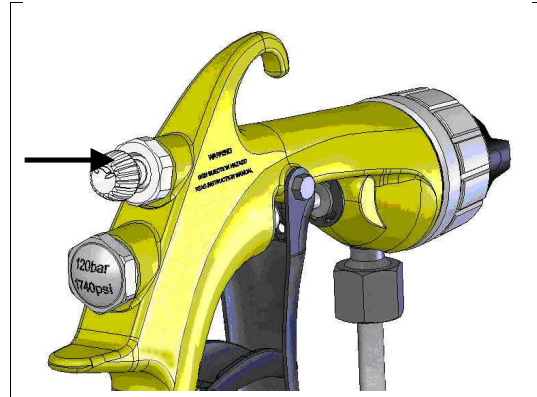

NB : if more material or less material is required, select another spray nozzle (refer to AIRMIX® spray nozzle chart).

GUN HANDLING

Keep the gun perpendicular to the surface to be painted and where possible keep the spray fan parallel to the work piece to give an equal coating thickness.

When spraying from a stationary gun position start the spray pass and trigger just before the leading edge. Release the trigger just before the spray pass ends, i.e. just after the trailing edge of the object.

Make sure that overlapping spray passes are even and regular.

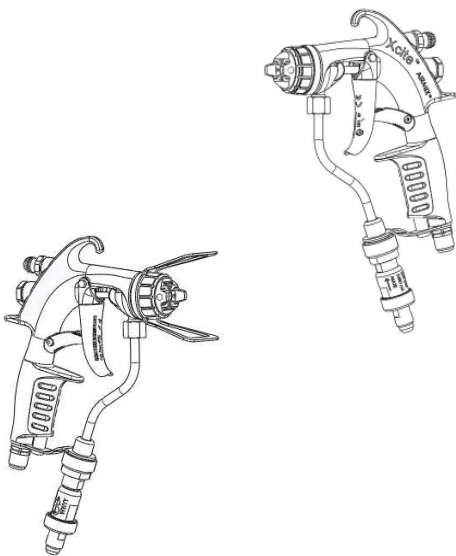

AIRMIX ® GUN

***Xcite*™**

TECHNICAL FEATURES

TRANSLATION FROM THE ORIGINAL DOCUMENT

IMPORTANT : before assembly and start-up, Please read and clearly understand all documents relating to this equipment (professional use only).

PICTURES AND DRAWINGS ARE NON CONTRACTUAL. WE RESERVE THE RIGHT TO MAKE CHANGES WITHOUT PRIOR NOTICE.

KREMLIN - REXSON

150, avenue de Stalingrad

93 245 - STAINS CEDEX – France

☎ : 33 (0)1 49 40 25 25 Fax : 33 (0)1 48 26 07 16

www.kremlin-rexson.com

1. DESCRIPTION

The Xcite™ gun is a manual AIRMIX® gun for professional use only.

There are three versions of the gun based upon the working pressure (120 bar / 1740 psi, 200 bar / 2900.6 psi or 400 bar / 5801.2).

The Xcite™ gun is an Airmix® spray gun with adjustable fan pattern, a swivel fitting and / or a inline-filter

It is recommended for spraying :

- for the versions, model 120 bar / 1740 psi and 200 bar / 2900.6 psi : varnishes, lacquers, colours, solvented or water-based products, high solid materials and is suitable for a wide range of 1K and 2K materials,
- for the version, model 400 bar / 5801.2 psi : single component adhesives and sealants, M.S.polymers, water-based adhesives, greases, waxes and a large range of thick materials.

2. TECHNICAL FEATURES

FEATURES	GUN Xcite™ - 120 bar / 1740 psi	GUN Xcite™ - 200 bar / 2900.6 psi	GUN Xcite™ - 400 bar / 5801.2 psi
Air supply pressure	Maximum 6 bar / 87 psi		
Maximum fluid supply pressure	120 bar / 1740 psi	200 bar / 2900.6 psi	400 bar / 5801.2 psi
Fluid flow rate	Depending on tip size (refer to Doc. : Spare parts)		
Weight (gun + air cap + nozzle)	517 g (with inline filter) 585 g (with swivel fitting)		600 g (with nozzle protection)
Maximum operating temperature	50°C / 117° F		
Air consumption (for a 22° C / 71.6° F temperature) (with air cap VX 24 K HVLP)			
Air pressure = 1 bar / 14.5 psi at the gun handle	3.8 m3/h / 2.237 c.f.m		
Air pressure = 2 bar / 29 psi at the gun handle	5.9 m3/h / 3.473 c.f.m		
Transfer efficiency (α) according to standard (EN 13966-1)	86 (± 2 %)		
Wetted parts	Stainless steel, PTFE		
Seat (removable)	Stainless steel	Carbide	
Fluid fitting	Inline filter or swivel fitting : M 1/2 JIC		
Air fitting	M 1/4 NPS		
Safety device	Safety lever		Safety lever + nozzle protection
Filter	Screen n° 6 mounted at the gun handle		
Weighted sound pressure (LAeq) (under pressure / with nozzle 09/094 / Handle air pressure = 1.5 bar / 21.75 psi)	80,7 dBa	82,5 dBa	83,8 dBa
Stress on the trigger (under pressure / with nozzle 04/074)	13,7 N (± 1 N) 3.08 Lbs (± 0.22 Lbs)	17,1 N (± 1 N) 3.8 Lbs (± 0.22 Lbs)	25,5 N (± 1 N) 5.7 Lbs (± 0.22 Lbs)

(\square) testing conditions :	Fluid pressure = 60 bar / 870 psi	Viscosity = 25 s (CA 4) or 50 mPas.s
	Handle air pressure = 1.5 bar / 21.75 psi	Temperature = 20.5 °C / 68.9 ° F
	Nozzle : 09/094	Relative humidity = 54%

NB : For HVLP compliance, the maximum inlet air pressure at the gun handle must not exceed 1 bar (14.5 psi) to maintain 0.7 bar (10.1 psi) or less at the air cap.

▪ **FAN WIDTH WITH VX24 AIR CAP**

Aircap with 2 pins and tip with 2 recesses



Tips	Pp = 35 bar / 507.6 psi		Pp = 70 bar / 1015.2 psi	
	L 1 (cm)	L 2 (cm)	L 1 (cm)	L 2 (cm)
04/094	20	7	20	8
04/114	22	7	23	9
06/094	21	7	21	10
06/114	23	8	23	11
06/134	25	8	27	13
06/154	28	8	31	15
09/094	21	8	23	11
09/114	22	7	23	12
09/134	25	8	27	13
09/154	28	9	29	15
12/094	21	8	22	11
12/114	24	8	26	12
12/134	26	9	28	16
12/154	26	9	30	15
12/174	31	10	33	17
14/094	22	8	22	11
14/114	23	8	24	12
14/134	27	9	28	15
14/154	29	9	32	16
14/174	30	12	33	20
18/134	27	13	29	19
18/154	29	15	32	21
18/174	31	15	33	23

L 1 : maximum fan width
(fan air control closed)

L 2 : reduced fan width
(fan air control opened)

Pp : fluid pressure

Testing conditions :

Gun handle air pressure = 1.5 bar / 21.75 psi

Viscosity = 45 s (CA 4) or 120 mPas.s

Temperature : 20°C / 68° F

Distance between the gun and the surface to be painted : 20 cm / 7.9"

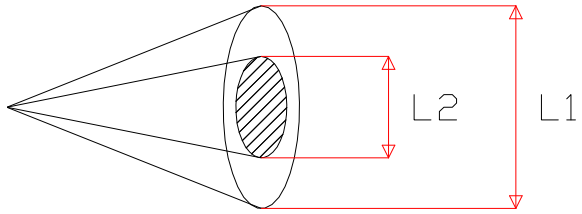

3. INSTALLATION

■ DESCRIPTION OF THE LABEL MARKING

Marking in accordance with the ATEX Directive

KREMLIN REXSON STAINS FRANCE	Name and address of the manufacturer	
CE 	CE : European conformity II : group II 2 : class 2 Surface equipment meant to an area where explosive atmospheres due to gas, vapours, mists are liable to appear from time to time in usual operating. G : gas	On the trigger
P air : 6 bar / 87 psi	Gun air supply maximum pressure	On the body
12	Marking of the manufacturing year (with 2 characters)	On the trigger
Xcite™	Gun model	On the body
P prod : xx bar	Maximum fluid pressure	On the sleeve

■ INSTALLATION DIAGRAM

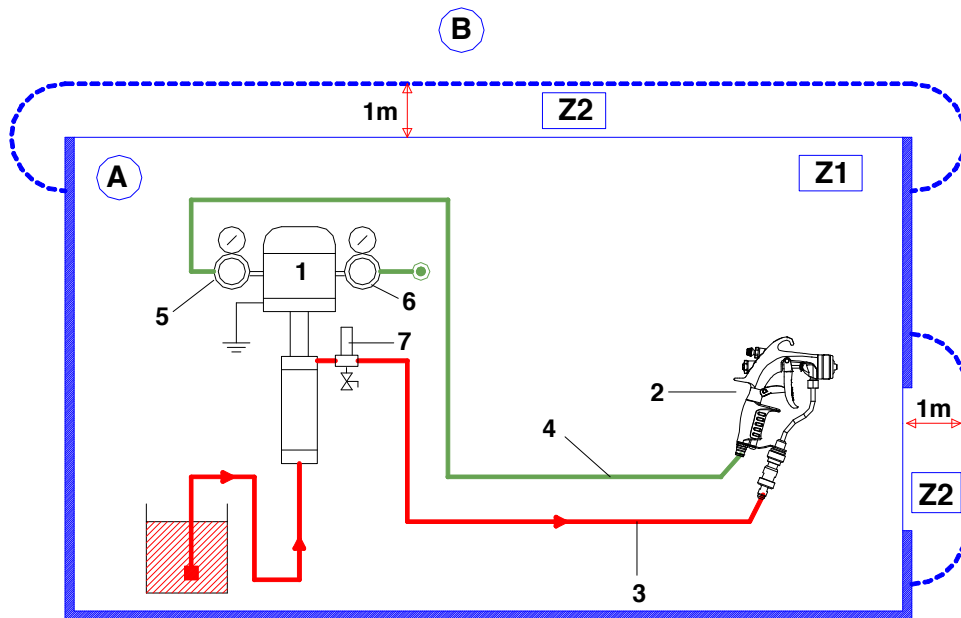

A	Explosive area : Area 1 (Z1) or area 2 (Z2) : spraybooth
B	Non-explosive area
1	Airmix® pump
2	Airmix® gun, model Xcite™
3	Airmix® fluid hose

4	Conductive air hose
5	Air regulator (→ spraying air)
6	Air regulator (→ fluid pressure)
7	Airmix® fluid filter



The 1 m / 39.37" distance indicated in these diagrams is given for information purposes only and hold harmless to KREMLIN REXSON. The user is responsible for the extraction and conditioning of the painting area where the equipment is used, for working conditions conditions (refer to EN 60079-10 standard). The 1 m / 39.37" distance may be modified if trials carried out by the user deem this necessary.



NB: Choose the appropriate pump to ensure that the working pressure supplied is suitable for the selected gun.

Please use a conductive air hose (minimum internal diameter : 7mm), for connecting the gun to the air regulator (capable of supplying at least 3 bar / 44 psi.).

Please ensure when fitting the **high pressure** paint hose, between the gun and the pump that the fittings are firmly tightened.



NB : In some particular cases, if the air hose (4) is a non-conductive hose, the fluid hose (3) must be conductive.

One of the 2 hoses (air or fluid) for the gun must be conductive.