

Festool GmbH
Wertstrasse 20
73240 Wendlingen
Germany

DISTRIBUTED BY:
Pro Wood Finishes
14622 Southlawn Lane
Rockville MD 20850
Ph: (301) 424-3033

FESTOOL

www.festoolusa.com

Instruction manual

Page 3

IMPORTANT: *Read and understand all instructions before using.*

Guide d'utilisation

Page 13

IMPORTANT: *Lire et comprendre toutes les instructions avant de démarrer les travaux.*

Manual de instrucciones

Pagina 24

IMPORTANTE: *Lea y comprende todas las instrucciones antes de usar.*

Instruction manual
Guide d'utilisation
Manual de instrucciones

R O T E X
RO 150 FEQ



701023_006



Contents

Safety rules	3
General Power Tool Safety Warnings	3
Machine-related safety instructions	4
Metal processing	5
Technical data	5
Symbols	5
Intended use	5
Electrical connection and operation	6
Extension cord	6
Electronic control	6
Tool settings	7
Dust extraction	7
Edge protector	7
Sanding motion	7
Choice and installation of sanding pads	8
Attaching the abrasive	8
Securing polishing attachments	8
Auxiliary handle	9
Working with the tool	9
Maintenance and care	9
Pad brake	9
Accessories, tools	10
Warranty	10
Table A: Sanding	11
Table B: Polishing	12

Safety rules

General Power Tool Safety Warnings



WARNING! Read all safety warnings and all instructions. Failure to follow the warnings and instructions may result in electric shock, fire and/or serious injury.

Save all warnings and instructions for future reference.

The term “power tool” in the warnings refers to your mains-operated (corded) power tool or batteryoperated (cordless) power tool.

1) Work area safety

a) **Keep work area clean and well lit.** Cluttered or dark areas invite accidents.

b) **Do not operate power tools in explosive atmospheres, such as in the presence of flammable liquids, gases or dust.** Power tools create sparks which may ignite the dust or fumes.

c) **Keep children and bystanders away while operating a power tool.** Distractions can cause you to lose control.

2) Electrical safety

a) **Power tool plugs must match the outlet. Never modify the plug in any way. Do not use any adapter plugs with earthed (grounded) power tools.** Unmodified plugs and matching outlets will reduce risk of electric shock.

b) **Avoid body contact with earthed or grounded surfaces, such as pipes, radiators, ranges and refrigerators.** There is an increased risk of electric shock if your body is earthed or grounded.

c) **Do not expose power tools to rain or wet conditions.** Water entering a power tool will increase the risk of electric shock.

d) **Do not abuse the cord. Never use the cord for carrying, pulling or unplugging the power tool. Keep cord away from heat, oil, sharp edges or moving parts.** Damaged or entangled cords increase the risk of electric shock.

e) **When operating a power tool outdoors, use an extension cord suitable for outdoor use.** Use of a cord suitable for outdoor use reduces the risk of electric shock.

f) **If operating a power tool in a damp location is unavoidable, use a residual current device (RCD) protected supply.** Use of an RCD reduces the risk of electric shock.

3) Personal safety

a) **Stay alert, watch what you are doing and use common sense when operating a power tool. Do not use a power tool while you are tired or under the influence of drugs, alcohol or medication.** A moment of inattention while operating power tools may result in serious personal injury.

b) **Use personal protective equipment. Always wear eye protection.** Protective equipment such as a dust mask, non-skid safety shoes, hard hat, or hearing protection used for appropriate conditions will reduce personal injuries.

c) **Prevent unintentional starting. Ensure the switch is in the off-position before connecting to power source and/or battery pack, picking up or carrying the tool.** Carrying power tools with your finger on the switch or energising power tools that have the switch on invites accidents.

d) **Remove any adjusting key or wrench before turning the power tool on.** A wrench or a key left

attached to a rotating part of the power tool may result in personal injury.

- e) **Do not overreach. Keep proper footing and balance at all times.** This enables better control of the power tool in unexpected situations.
- f) **Dress properly. Do not wear loose clothing or jewellery. Keep your hair and clothing away from moving parts.** Loose clothes, jewellery or long hair can be caught in moving parts.
- g) **If devices are provided for the connection of dust extraction and collection facilities, ensure these are connected and properly used.** Use of dust collection can reduce dust-related hazards.
- h) **Do not let familiarity gained from frequent use of tools allow you to become complacent and ignore tool safety principles.** A careless action can cause severe injury within a fraction of a second.

4) Power tool use and care

- a) **Do not force the power tool. Use the correct power tool for your application.** The correct power tool will do the job better and safer at the rate for which it was designed.
- b) **Do not use the power tool if the switch does not turn it on and off.** Any power tool that cannot be controlled with the switch is dangerous and must be repaired.
- c) **Disconnect the plug from the power source and/or the battery pack from the power tool before making any adjustments, changing accessories, or storing power tools.** Such preventive safety measures reduce the risk of starting the power tool accidentally.
- d) **Store idle power tools out of the reach of children and do not allow persons unfamiliar with the power tool or these instructions to operate the power tool.** Power tools are dangerous in the hands of untrained users.
- e) **Maintain power tools and accessories. Check for misalignment or binding of moving parts, breakage of parts and any other condition that may affect the power tool's operation. If damaged, have the power tool repaired before use.** Many accidents are caused by poorly maintained power tools.
- f) **Keep cutting tools sharp and clean.** Properly maintained cutting tools with sharp cutting edges are less likely to bind and are easier to control.
- g) **Use the power tool, accessories and tool bits etc. in accordance with these instructions, taking into account the working conditions and the work to be performed.** Use of the power tool for operations different from those intended could result in a hazardous situation.

- h) **Keep handles dry, clean and free from oil and grease.** Slippery handles do not allow for safe handling and control of the tool in unexpected situations.

5) Service

- a) **Have your power tool serviced by a qualified repair person using only identical replacement parts.** This will ensure that the safety of the power tool is maintained.

Machine-related safety instructions

- **Harmful/toxic dusts can be produced during your work (e.g. lead-containing paint, some types of wood and metal).** Contact with these dusts, especially inhaling them, can represent a hazard for operating personnel or persons in the vicinity. Comply with the safety regulations that apply in your country. Connect the electric power tool to a suitable extraction system.



To protect your health, wear a P2 protective mask.



Always wear protective goggles to protect against sanding hazards.

- **Prevent liquid polish from entering the machine.** The penetration of liquid polish into the electric power tool increases the risk of an electric shock.
- **If the power tool is dropped or falls, check for damage to the machine and sanding pad. Remove the sanding pad for closer inspection. Repair damaged parts before using again.** Broken sanding pads and damaged machines can cause injuries and machine instability.

Metal processing



When processing metal, the following measures must be taken for safety reasons:

- Install an upstream residual-current circuit-breaker (FIG, PRCD).
- Connect the tool to a suitable dust extractor.
- Regularly remove dust deposits in the motor housing.



Wear protective goggles.

Health hazard by dust

⚠ WARNING Various dust created by power sanding, sawing, grinding, drilling and other construction activities contains chemicals known (to the State of California) to cause cancer, birth defects or other

reproductive harm. Some examples of these chemicals are:

- Lead from lead-based paints,
- Crystalline silica from bricks and cement and other masonry products,
- Arsenic and chromium from chemically-treated lumber.

The risk from these exposures varies, depending on how often you do this type of work.



To reduce your exposure to these chemicals work in a well ventilated area and use approved safety equipment, such as dust masks that are specially designed to filter out microscopic particles. Wash hands after handling.

⚠ WARNING TO REDUCE THE RISK OF INJURY, USER MUST READ INSTRUCTION MANUAL.

Technical data

Wattage	720 W
No load speed	3300 - 6800 rpm
Sanding stroke	5 mm (0.2 in.)
Sanding base dia.	150 mm (5.9 in.)
Weight	2.3 kg (5.1 lbs.)
Safety level	□ / II

Symbols



Warning of general danger



Read the Operating Instructions/Notes!



Wear protective goggles



Wear ear protection



Wear a dust mask

V Volts

A Amperes

Hz Hertz

W Watt

~ Alternating current

n_0 No load speed

□ Class II Construction

rpm Revolutions per minute

∅ Diameter

Intended use

The sanders are designed for sanding and polishing wood, plastic, metal, composite materials, paint/varnish, filler and similar materials.

Do not use with materials containing asbestos.

The tools must not be used when wet or damp, or operated in a damp environment, for electrical safety reasons. Use this sander only for dry sanding.

⚠ WARNING The user bears sole responsibility for any damage or accidents resulting from incorrect use.

Electrical connection and operation

The mains voltage must correspond to the voltage on the rating plate!

See the adjacent figure for connection and disconnection of the power cord.

⚠ WARNING Always switch the tool off before connecting or disconnecting the power cord!

To start the tool, push the switch (2.1) forwards. Slight pressure on the rear end of the switch is sufficient to switch the tool off.

Extension cord

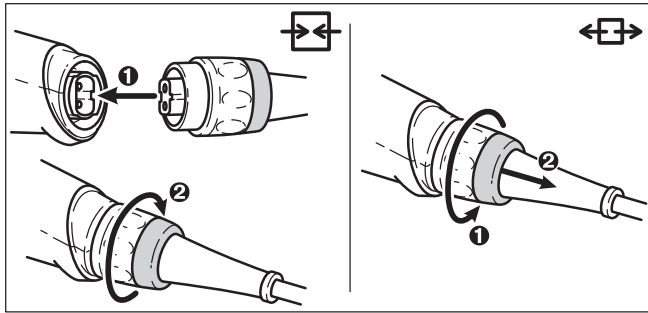

If an extension cord is required, it must have sufficient cross-section to prevent an excessive drop in voltage or overheating. An excessive drop in voltage reduces the output and can lead to failure of the motor. The table adjacent shows you the correct cord diameter as a function of the cord length for the RO 150 FEQ.

Use only U.L. and CSA listed extension cords. Never use two extension cords together. Instead, use one long one.

Note: The lower the AWG number, the stronger the cord.

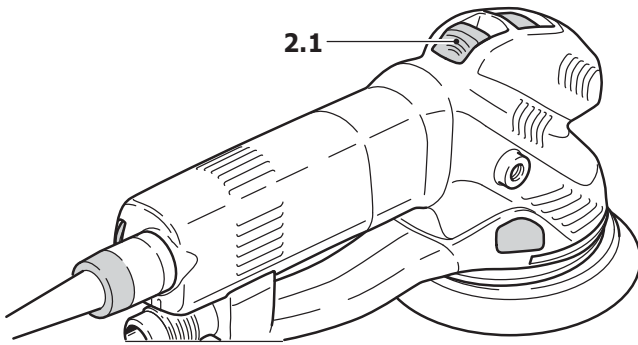

Total Extension Cord Length (feet)	25	50	100	150
Cord size (AWG)	18	16	16	14

Electronic control



The tool has full-wave electronics with the following features:

Smooth start-up

The smooth start-up ensures jolt-free startup.

Speed adjustment

You can regulate the speed steplessly between 3300 and 6800 rpm using the adjusting wheel (3.1). This lets you optimize the sanding speed to suit the material.

Constant speed

The pre-selected speed remains constant whether the tool is in operation or in neutral position.

Temperature control

To prevent overheating, the safety electronics switch the tool off when it reaches a critical motor temperature. Let the tool cool down for approx. 3-5 minutes before using it again. The tool requires less time to cool down if it is running, i.e. in neutral position.

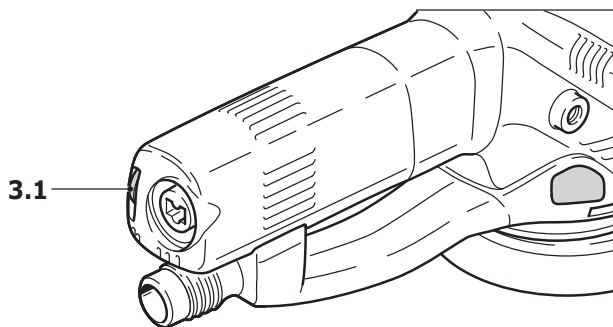

Tool settings

⚠ WARNING Always remove the power plug from the socket before carrying out any work on the power tool.

Dust extraction



Always connect the machine to a dust extractor when performing work that generates dust.

You can connect a Festool extractor with an extractor hose diameter of 27 mm to the dust extraction port (4.2).

The extraction adapter (4.3) can be removed if necessary. To do this, press the locking button (4.1), draw the extraction adapter backwards and pull off. To reattach the extraction adapter, insert it as shown in Fig. 4 and slide it towards the sanding pad until the locking button (4.1) latches into place.

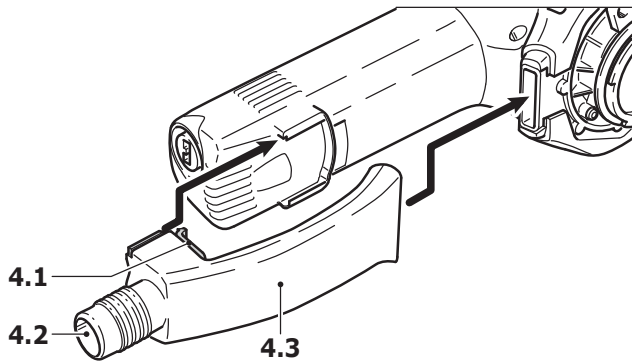

Edge protector

The edge protector (5.1) prevents the sanding pad from touching the edge perpendicular to a surface (e.g. when sanding along a wall), thereby preventing the machine from rebounding.

Assembly: Slide the edge protector onto the machine until it latches into place.

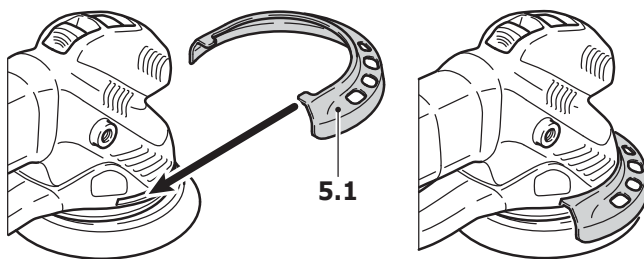

Sanding motion

You can use the switch (6.1) to set two different sanding motions.

CAUTION The change from eccentric motion (fine sanding) to Rotex rotary motion (coarse sanding) can only be made when the sanding pad is stationary, as the switch is locked in place during operation for reasons of safety.

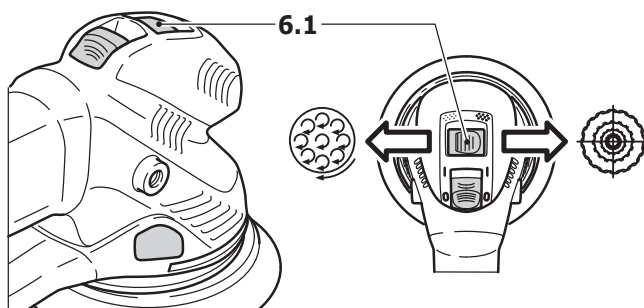

Rotex rotary motion (coarse sanding, polishing)



The Rotex rotary motion is a combination of rotary and eccentric motions. This motion is recommended for sanding with aggressive material removal (coarse sanding) and polishing.

Slide the switch (6.1) into the right position.

Eccentric motion (fine sanding)



This motion is recommended for sanding with low material removal for a scratch-free finish (fine sanding).

Press the switch (6.1) downwards and push it into the left-hand position.

Choice and installation of sanding pads

The tool can be fitted with three sanding pads of different hardnesses depending on the surface to be sanded.

Hard: Coarse sanding on surfaces, sanding at edges.

Soft: Universal use for coarse and fine sanding for flat and curved surfaces.

Super-soft: Fine sanding on formed parts, curves, radii. Do not use on edges!

Installation

The FastFix system enables tool-free replacement of the sanding pad (7.4):

- Set the switch (7.1) to the right, to the Rotex rotary motion
- Press spindle stop (7.2),
- Turn the fitted sanding pad from the spindle (right-handed thread)
- Keep the spindle stop pressed and screw on the new sanding pad (in doing so, make sure that the rubber collar (7.3) is correctly fitted!).
- Let go of the spindle stop.

⚠ CAUTION Actuate the spindle stop only when the drive spindle is stationary. Do not switch on the motor when the spindle stop is pressed in.

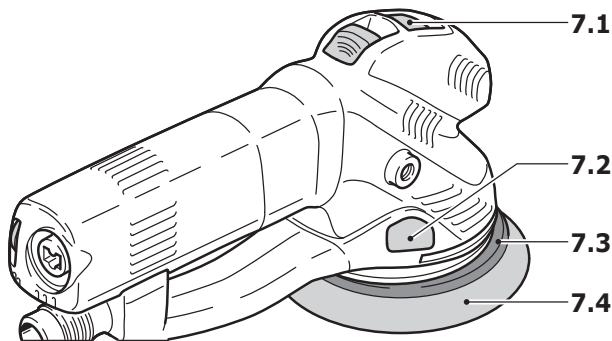

Attaching the abrasive



Stickfix is a hook-and-loop fastening system. Stickfix sanding pads allow the use of self-adhesive hook-and-loop abrasives such as Stickfix sandpapers and sanding cloths.

Simply press the abrasive onto the sanding pad and pull it off again after use.

⚠ WARNING Use only abrasives with an undamaged Stickfix hook-and-loop coating. Before use, check that the coating has not been damaged by improper use (such as overheating).

Securing polishing attachments

To prevent damage, use PoliStick polishing attachments (sponges, felt, lambswool bonnets) only with the special polishing pad fitted on the tool instead of a sanding pad. Like StickFix abrasives, the PoliStick polishing attachments are simply pressed onto the polishing pad and pulled off after use.

Auxiliary handle

The auxiliary handle (Accessories, 8.1) can be screwed onto either the right or left of the gear head.

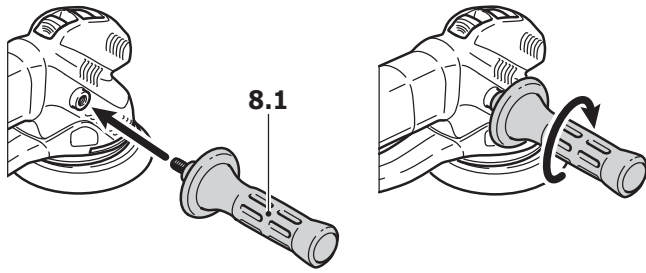

Working with the tool

⚠ WARNING Always secure the workpiece in such a manner that it cannot move while being sanded.

⚠ CAUTION Never overload the tool by using too much pressure! The best sanding results are achieved when applying moderate pressure. Sanding performance and quality depend primarily on the choice of the right abrasive.

For safe guidance, hold the tool with both hands.

Application

Tables A and B show the settings we recommend for different sanding and polishing work.

Maintenance and care

⚠ WARNING All maintenance or repair work requiring the motor housing to be opened must be carried out only by an authorized service workshop. Maintenance or repair work carried out by an unauthorized person can lead to the incorrect connection of the wiring or other components, which in turn can lead to accidents with serious consequences.

⚠ WARNING Always remove the plug from the mains supply socket before carrying out any work on the machine!

Always keep the tool and in particular the ventilation slots clean.

Pad brake

The rubber collar (9.1) prevents the sanding pad from revving up to maximum speed in an uncontrolled manner during eccentric motion (fine sanding). Because the collar wears down in the course of time, it has to be replaced by a new one (order no. 465472) as soon as there is any reduction in the braking effect.

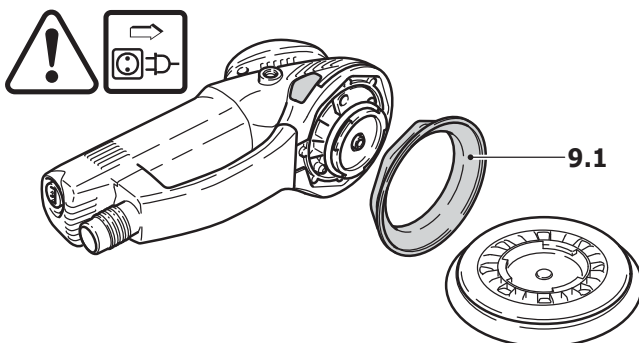

Accessories, tools

⚠ WARNING For safety reasons, only use original Festool accessories and tools!

The accessory and tool order number can be found in the Festool catalog or on the Internet under www.festoolusa.com.

Systainer

Many Festool products are shipped in a unique system container, called "Systainer".

This provides protection and storage for the tool and accessories. The Systainers are stackable and can be connected together. They also can be connected atop Festool CT dust extractors.

To open the Systainer:



- Turn the T-loc [10-1] to the position .

To lock the Systainer:

- Turn the T-loc [10-1] to the position .

To connect two Systainers:

- Place one Systainer on the top of the other (Fig. A).

- Turn the T-loc [10-1] to the position  or  (Fig. B).

The Systainers are connected and locked.

- ① A new generation Systainer is connectable on top of a previous generation Systainer by the four latches of the previous Systainer.

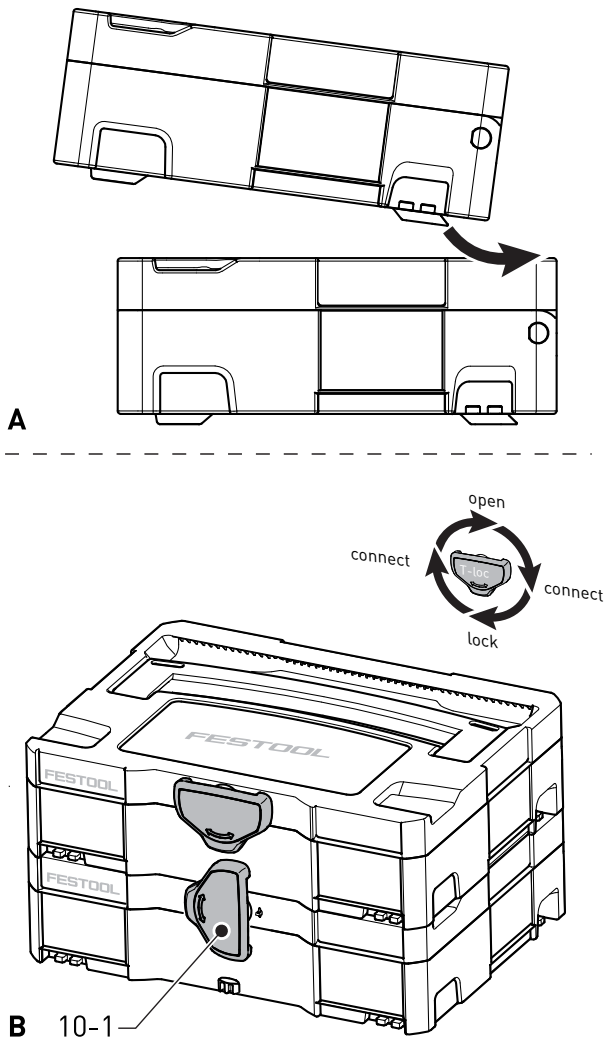

Warranty

Festool offers a 3 year limited warranty, one of the strongest in the industry. This warranty is valid on the pre-condition that the tool is used and operated in compliance with the Festool operating instructions. Festool warrants that the specified tool will be free from defects in materials and workmanship for a term of 3 years from the date of purchase.

Conditions of 1 + 2 warranty

All customers receive a free extended limited warranty (1 year + 2 years = 3 Years) on new Festool power tools purchased from an authorized retailer. Festool is responsible for all shipping costs during the first year of the warranty. During the second and third year of the warranty the customer is responsible for shipping the tool to Festool. Festool will pay for return shipping to the customer using UPS Ground Service. All warranty service is valid 3 years from the date of purchase on your receipt or invoice. Proof of purchase may be required.

Excluded from the coverage under this warranty are: normal wear and tear, damages caused by misuse, abuse, or neglect; damage caused by anything other than defects in material and workmanship. This warranty does not apply to accessory items such as circular saw blades, drill

bits, router bits, jigsaw blades, sanding belts, and grinding wheels. Operating a tool at a voltage or frequency different from the tool's rating will void the warranty. This includes the usage of the tool in combination with a transformer. Festool does not condone nor support the use of any non-Festool engineered, designed, and manufactured accessories or consumables with Festool products. Use of any non-Festool products may affect performance or void the warranty. Festool is not responsible for any damages or losses incurred and user assumes all risk and responsibility with non-Festool derived products. Also excluded are "wearing parts," such as carbon brushes, lamellas of air tools, rubber collars and seals, sanding discs and pads, and Festool gear (hats and shirts).

The obligations of Festool in its sole discretion under this warranty shall be limited to repair or replacement or a refund of the purchase price for any Festool portable power tool that is found to have a defect in materials or workmanship during the warranty period. FESTOOL SHALL NOT BE LIABLE FOR ANY CONSEQUENTIAL, INCIDENTAL OR SPECIAL DAMAGES REGARDLESS OF THE THEORY OF LAW ON WHICH THE CLAIM IS BASED. ALL WARRANTIES IMPLIED BY STATE LAW, INCLUDING THE IMPLIED WARRANTIES OR MERCHANTABILITY AND FITNESS FOR A PARTICULAR PURPOSE ARE HEREBY LIMITED TO THE DURATION OF THREE YEARS.

Some states in the U.S. and some Canadian provinces do not allow the limitations on how long an implied warranty lasts, so the above limitation may not apply to you. This warranty gives you specific legal rights, and you may also have other rights that vary from state to state in the U.S. and from province to province in Canada.

With the exception of any warranties implied by state or province law as limited above, the foregoing express limited warranty is exclusive and in lieu of all other warranties, guarantees, agreements, and similar obligations of Festool. Festool makes no other warranty, express or implied, for Festool portable power tools. This warranty policy is only valid for tools that are purchased in the US and Canada. Warranty policies of other countries may vary when obtaining warranty service outside the US and Canada. Some countries do exclude warranty for products bought outside their territory. Festool reserves the right to reject the repair of any tool that is not part of the US/Canada product line. No agent, representative, distributor, dealer, or employee of Festool has the authority to increase or otherwise change the obligations or limitations of this warranty.

Table A: Sanding





















Table A: Sanding	Coarse sanding			Fine sanding			
							
 Paintwork, filler	X		5 - 6	soft	X	1- 3	super soft
 Paintwork, paint	X		5 - 6	hard	X	3 - 6	hard
 Wood, veneered surface	X		5 - 6	hard	X	3 - 6	soft
 Plastics	X	X	4 - 6	soft	X	1 - 4	soft
 Steel, copper, aluminium	X		6	soft	X	3 - 6	soft

Table B: Polishing

Table B: Polishing		Polishing	Sealing	High-gloss polishing
Paintwork		6	3	4 - 6
		Sponge, coarse/fine	Sponge, fine, honeycombed	Sheepskin
		Polishing paste	Hard wax	-
		6	3	6
Plastics		Felt, hard	Felt, soft	Sheepskin
		Polishing paste	Hard wax	-
		6	3	6